

DESIGN ■ DEVELOP ■ DELIVER ■ DOMINATE

# ARMY AL&T

ASC.ARMY.MIL

OCTOBER-DECEMBER 2014



ANNIVERSARY

ARMY ACQUISITION CORPS

## TALK BACK

For more news, information and articles, please go to the USAASC website at

<http://asc.army.mil>.

Click on the Publications tab at the top of the page.

To contact the Editorial Office:  
Call 703-805-1034/1038  
or DSN 655-1034/1038

Articles should be submitted to:  
DEPARTMENT OF  
THE ARMY  
ARMY AL&T  
9900 BELVOIR RD.  
FORT BELVOIR, VA  
22060-5567

Email:  
[usarmy.belvoir.usaasc.list](mailto:usarmy.belvoir.usaasc.list),  
[usaascweb-army-alt-magazine@mail.mil](mailto:usaascweb-army-alt-magazine@mail.mil)  
or  
[armyalt@gmail.com](mailto:armyalt@gmail.com)

# From the Editor-in-Chief

I was one of hundreds of mourners in the Aug. 14 funeral procession that made its way through Arlington Cemetery, past the rows of simple white gravestones, to Area 60, MG Harold J. Greene's final resting place. Greene, a highly decorated Soldier, Army acquisition leader and friend, became the highest-ranking fatality in war since Vietnam after an Afghan soldier opened fire on Aug. 5. Along the way, I could not help but think about how combat had taken not only a loving husband and father from his family, but a rare talent from the Army and America as well.

Losing Greene was especially poignant not because he was a general officer, or even because of what he accomplished during his distinguished career, but because of what was yet to come. With a Ph.D. from the University of Southern California in materials science and several master's degrees, Greene had a wealth of knowledge and experience. His easygoing manner and self-deprecating humor belied his genius. His ability to form instant connections with people and organize teams to attack vexing problems is legend within the acquisition community. What impact he might have had on Army acquisition in future years is purely conjecture, but it's safe to say it would have been momentous. Harry, you will be missed.

The weapon systems, protective gear and communication networks needed for that future force do not appear because of some PowerPoint briefing. No, a cadre of government employees, like Greene, alongside a legion of defense contractors works tirelessly to outfit what is universally acknowledged as the best-trained, -equipped and -led Army ever fielded. Greene was but one member of the 12,000-strong Army Acquisition Corps (AAC), part of the larger, nearly 38,000-strong Army Acquisition Workforce that has flourished over the past 25 years, who bring their skills to bear on the complicated problem of national defense every single day.

The formation of the AAC, a dedicated corps of military and civilian acquisition leaders, was approved on Oct. 13, 1989, by then-Army Chief of Staff GEN Carl E. Vuono. As a result, the past quarter-century has seen an unprecedented increase in the quality of Army Acquisition professionals and the products they create; to wit, 97.5 percent of the Army Acquisition Workforce is certified in their profession, according to standards outlined in the Defense Acquisition Workforce Improvement Act. That 97.5 percent is the best in DOD and rivals any industry! In other words, Army Acquisition people are the experts in acquisition. Don't believe it? Just take a look at what our workforce has accomplished since 1989:

- M109A6 Paladin.
- AH-64D Longbow Apache.
- Interceptor Body Armor.
- Rapid Fielding Initiative.
- Mine Resistant Ambush Protected vehicles.
- MQ-1C Gray Eagle unmanned aircraft.
- Nett Warrior.
- Double-arm and face transplants.

As impressive as the past 25 years have been, the best is yet to come. In this issue, learn how the U.S. Army Materiel Command eschews the status quo and questions past practices, in "Forging New Links." See how the folks at Picatinny Arsenal, NJ, are adapting the M119A3 howitzer to handle the rigors of high-altitude mountain warfare of Afghanistan in "Adapting Artillery." Finally, sit back, relax with a cup of coffee (hint) and read how Starbucks recruits and retains top talent in "Critical Thinking."

For more stories and expanded coverage, please check our online magazine at <http://usaasc.army.alt.com/>. If you have comments or questions, or want to submit an idea for future issues, write me at [ArmyALT@gmail.com](mailto:ArmyALT@gmail.com).

*Nelson McCouch III*  
*Editor-in-Chief*

# ARMY AL&T

OCTOBER–DECEMBER 2014

**SUBSCRIBE**

TO RECEIVE THE PRINT VERSION OF THE MAGAZINES AND E-MAIL ALERTS WHEN NEW ISSUES ARE AVAILABLE.

## FEATURES



### FROM THE AAE

- 4** 25 YEARS AND COUNTING  
Army Acquisition Corps coalesces around dedication, professionalism
- 8** IN MEMORIAM  
MG Harold J. Greene

### ACQUISITION



- 14** SPOTLIGHT: MR. RALPH P. "PAT" DEGROODT  
Sailing trip benefits battlefield communications
- 16** LESSONS OUTSIDE THE LINES  
PEO adds knowledge capture to its arsenal of acquisition tools
- 22** GROUND TRUTH  
Lessons Learned in the Army Acquisition Workforce
- 26** TRAIN TO SUSTAIN  
Interactive multimedia instruction uses lifelong learning methodologies to support battlefield communication systems



### LOGISTICS

- 32** SPOTLIGHT: MAJ JAMES A. "TONY" LINDH II  
Combining different viewpoints for better analytics
- 34** FORGING NEW LINKS  
With Supply Chain Transformation initiative, Army Materiel Command seeks greater efficiencies, better communication
- 40** SMART SUSTAINMENT  
Tobyhanna workforce supports the current and future Army network, one idea at a time



### SCIENCE & TECHNOLOGY

- 48** SPOTLIGHT: MR. JONATHAN HENSHEY  
Active-duty perspective benefits acquisition career
- 50** FUTURE [WORK]FORCE  
Developing the Army's next generation of scientists and engineers
- 56** ELITE TRAINING  
New game-based simulation expands to teach new leaders 'soft skills'
- 62** ADAPTING ARTILLERY  
Design change strengthens battle-worn M119A3 howitzer at less cost than new system



### CONTRACTING

- 70** SPOTLIGHT: MRS. R. COLETTE CARRIZALES  
A winding road to Texas
- 72** SKILL SEEKERS  
Annual contracting support exercise grows in participation, scope and stature



### ON THE COVER

Twenty-five years ago, then-Army Chief of Staff GEN Carl E. Vuono signed a letter formally creating the Army Acquisition Corps (AAC). With this issue, we celebrate 25 years of Army acquisition excellence, and the professionalism that the AAC represents.

THE HONORABLE HEIDI SHYU

Assistant Secretary of the Army  
for Acquisition, Logistics and Technology  
(ASA(ALT))/Army Acquisition Executive

EDITORIAL BOARD

LTG JEFFREY W. TALLEY  
Chief, U.S. Army Reserve/Commanding General  
(CG), U.S. Army Reserve Command

LTG JAMES O. BARCLAY III  
Deputy Chief of Staff (DCS), G-8

LTG PATRICIA E. MCQUISTION  
Deputy CG/Chief of Staff, U.S. Army Materiel Command

LTG ROBERT S. FERRELL  
U.S. Army Chief Information Officer/G-6

LTG MICHAEL E. WILLIAMSON  
Director, Army Acquisition Corps and Director,  
Acquisition Career Management

MG (DR.) BRIAN C. LEIN  
CG, U.S. Army Medical Research  
and Materiel Command

BG KIRK F. VOLLMECKE  
Deputy for Acquisition and Systems  
Management, OASA(ALT)

WIMPY D. PYBUS  
Deputy Assistant Secretary of the Army (DASA)  
for Acquisition Policy and Logistics,  
Office of the ASA(ALT) (OASA(ALT))

DR. JEFFERY P. HOLLAND  
Director of Research and Development/  
Chief Scientist, U.S. Army Corps of Engineers

ROY A. WALLACE  
Assistant DCS, G-1

MARY MILLER  
DASA for Research and Technology, OASA(ALT)

THOMAS E. MULLINS  
DASA for Plans, Programs  
and Resources, OASA(ALT)

HARRY P. HALLOCK  
DASA for Procurement, OASA(ALT)

ANN CATALDO  
DASA for Defense  
Exports and Cooperation, OASA(ALT)

GABRIEL CAMARILLO  
Principal Deputy, ASA(ALT)

CRAIG A. SPISAK  
Director, U.S. Army Acquisition  
Support Center (USAASC)

NELSON MCCOUCH III  
Executive Secretary,  
Editorial Board, USAASC

## FEATURES

### ? CRITICAL THINKING

**78** 'SEMPER GUMBY'  
A former Marine recruiter's job with Starbucks is all about connection

### \$ BBP 2.0

**88** SPOTLIGHT: MS. JUDY COLE  
Performance improvement imperative

**90** COST IS KEY  
Kendall and Gansler praise workforce,  
urge affordability as a requirement

### COMMENTARY

**96** IN IT FOR THE LONG HAUL  
The work done by the Army Acquisition Corps makes a difference far into the future

**104** TIME TO THINK  
Technology, demands of war have sharpened contracting workforce; now it's time to reflect on what's next

**110** CHANGING MISSION, CHALLENGING CLIMATE  
Looking back on 37 years of contracting

**116** PULLING TOGETHER  
Collaboration drives integration,  
which in turn drives the future force



## DEPARTMENTS

 **138 CAREER CORNER**

**148 ON THE MOVE**

 **156 THEN & NOW**

### EDITORIAL STAFF

NELSON MCCOUCH III  
Editor-in-Chief

MARGARET C.  
"PEGGY" ROTH  
Senior Editor

ROBERT E. COULTAS  
Departments Editor

STEVE STARK  
Editor

CATHERINE DERAN  
Layout and Graphic Design

Army AL&T magazine (ISSN 0892-8657) is published quarterly by the ASA(ALT). Articles reflect views of the authors and not necessarily official opinion of the Department of the Army. Articles may be reprinted if credit is given to Army AL&T magazine and the author.

Private subscriptions and rates are available from: Superintendent of Documents, U.S. Government Printing Office, Washington, DC 20402 202-512-1800

Periodicals official postage paid at Fort Belvoir, VA, and additional post offices.

POSTMASTER:  
Send address changes to:  
DEPARTMENT OF THE ARMY  
ARMY AL&T  
9900 BELVOIR RD  
FORT BELVOIR, VA 22060-5567

This medium is approved for official dissemination of material designed to keep individuals within the Army knowledgeable of current and emerging developments within their areas of expertise for the purpose of enhancing their professional development.

Official:

By Order of the  
Secretary of the Army:



RAYMOND T. ODIERNO  
General, United States Army  
Chief of Staff

GERALD B. O'KEEFE  
Administrative Assistant to the  
Secretary of the Army  
1423702



## OUTSIDE THE BOX

**122 THINKING INSIDE THE BOX**  
How a shipping container became a weapon system



## WORKFORCE

**126 ARMY ACQUISITION: A BRIEF HISTORY**  
Legislation, scandal, regulation, reform

**128 FACES OF THE FORCE**  
The Army Acquisition Workforce in pictures

**132 THE FULL TREATMENT**  
Medical Command conducts comprehensive overhaul of acquisition specialties

### ELECTRONIC EXTRAS

Even die-hard hard-copy readers will want to check out the electronic extras available on the app and online version of Army AL&T. Go to <http://usaasc.armyalt.com/> or use the iOS or Android app to view additional content related to the stories in this edition and more Faces of the Force photos. The + icon in the electronic versions indicates additional content.





### ROUGH TERRAIN AHEAD

SPC Jackie Tackett, an automated logistics specialist for the 349th Quartermaster Company, California Army National Guard, drives a rough terrain container handler March 23 at Kandahar Airfield, Afghanistan. The Army also faces rough terrain as it plans for the future, because of budget uncertainty. (U.S. Army photo by SFC Jon Cupp, 82nd Sustainment Battalion – U.S. Army Central Command Materiel Recovery Element Public Affairs)



FROM THE AAE



FROM THE AAE



FROM THE ARMY ACQUISITION EXECUTIVE  
THE HONORABLE HEIDI SHYU

# 25 YEARS *and* COUNTING

## Army Acquisition Corps coalesces around dedication, professionalism

*“We know that the quality of our people is an essential ingredient to our success as an acquisition enterprise.”—Former Deputy Secretary of Defense Dr. Ashton B. Carter*

**T**he Army Acquisition mission is to provide our Soldiers a decisive advantage by developing, acquiring, fielding and sustaining the best-equipped Army the world has ever known. Accomplishing that feat requires a dedicated workforce of career civilians and military professionals. This year, we celebrate 25 years of acquisition excellence, marking the creation in 1989 of the Army Acquisition Corps (AAC), the civilian and military specialists who develop and procure the myriad capabilities the Army employs for its mission.

Led by the Army acquisition executive, program executive officers (PEOs) and program managers, this dedicated team supports the Soldier with the critical systems and services that enable our Soldiers to fight and win our nation’s wars. Along with the larger Army Acquisition Workforce, the AAC is the premier developer of the materiel solutions needed for a strategically responsive force. Our acquisition professionals consistently manage the delicate balance of delivering capabilities while serving as good stewards of taxpayer resources. To celebrate this milestone achievement, we are highlighting the contributions of the workforce in this issue of Army AL&T magazine.

When conceived in the late 1980s, the AAC was envisioned to professionalize the workforce needed to achieve the best value for the taxpayer while fielding the best equipment.





**DIMENSIONAL REQUIREMENTS**

Annette LaFleur, team leader for the U.S. Army Natick Soldier Research, Development and Engineering Center’s Design, Pattern and Prototype Team, uses a 2-D design program, but she is excited about the possibilities that 3-D printing capabilities hold for her industry and for Soldiers. Quick prototyping with 3-D printing—or additive manufacturing—is just one of many dimensions to the work that the Army Acquisition Workforce does for the benefit of the Soldier and the nation. (U.S. Army photo by David Kamm)



**GENESIS TO GRAVE**

CPT Michael Andersen and CPT Joy Harry transport a heavy-duty military tow bar July 20 to the 401st Army Field Support Brigade (AFSB) facility at Bagram Airfield, Afghanistan. Acquisition personnel work the whole spectrum of Army materiel and services, from genesis to operation to grave. (Photo by Sharonda Pearson, 401st AFSB Public Affairs)

Such a workforce would incorporate uniformed personnel to better understand military and operational needs for materiel and services. The AAC was created to bridge generating force processes with the operational force needs it serves, and it has performed this role with remarkable success.

In establishing the AAC, the Army professionalized the Acquisition Workforce, defining career trajectories for military and civilian acquisition workers with clear expectations for education, training, experience and assignments that promote competence and skill among the workforce. As DOD recognized in the Better Buying Power initiative, a professional workforce has been instrumental to success in an environment of constrained resources. There is simply no substitute for informed, rational business judgment at every level of our workforce. The AAC, by design, has expertly exercised such judgment throughout a critical time.

The greater Army Acquisition Workforce has approximately 38,000 members worldwide. It pulls together professionals from across Army organizations, including PEOs, the U.S. Army Materiel Command, Space and Missile Defense Command, Test and Evaluation Command, Medical Command and numerous others. Army Acquisition professionals are engineers, scientists, logisticians, contract specialists, testers, program managers and cost estimators, among other specialties.

This broad array of skill sets is necessary to effectively manage the myriad programs, both existing and nascent, that the Army must have to maintain its dominance—and do it all in a budget environment that demands we do more with less. While resources are shrinking, our threats are not. The Army’s research,





**TARGET: PRECISION**

1SG Justin Rotti, a combat developer from the U.S. Army Training and Doctrine Command’s Fire Cell, Fires Center of Excellence, uses a developmental handheld precision targeting device during a test at White Sands Missile Range, NM. Testing is among the many vital functions that acquisition personnel perform. (Photo by John Andrew Hamilton, U.S. Army Test and Evaluation Command)

development and acquisition resources have reached historic lows, and we must maximize the efficient use of these finite assets because our Soldiers are depending on us. The choices we make today will affect and shape the capabilities we provide to future generations of Soldiers.

Army Acquisition is emphasizing several goals: First, we’re focusing on long-range planning, making sure that we make acquisition decisions with sustainment costs in mind. We’re also focusing on the quality of our dedicated contracting workforce, professionals who must amass years of experience to be optimally effective. Our science and technology portfolio is another area of focus, as the Army protects its seed corn for future capabilities.

As the Army is called to protect the nation against emerging threats, Army Acquisition will support that mission with advanced technologies, equipment and services. Acquisition must continue to encourage and develop our greatest resource—our people. We are fostering that growth in our workforce with planned initiatives such as tuition assistance, rotations with industry and increased recognition for outstanding workforce members. My personal mission is to ensure that the Acquisition Workforce grows the right skill sets to meet our challenges—and continues for another 25 years and beyond to demonstrate excellence in supporting the warfighter and the taxpayer.

As I celebrate the accomplishments of the AAC, I want to take a moment to

recognize and remember one of its most exceptional members. MG Harold J. Greene exemplified the very best of the Army. He was a Soldier of incredible talent, tremendous intellect, and unwavering fidelity and devotion. An officer without pretense, he acted in the best interest of those entrusted to his command, earning the respect of his superiors, subordinates and peers. He possessed a great sense of humor and forthright demeanor. Harry was an American hero who could have chosen many paths in life. But it was his love of country and his family’s legacy of service that led him to join the greatest Army the world has ever known, and he was dedicated to ensuring that our Soldiers are equipped with the very best. He was proud to serve and dedicated his life to the Army.





GREENE

U.S. ARMY



## IN MEMORIAM

# MG Harold J. Greene, 1959-2014

In his 34 years of service to the Army, MG Harold J. Greene made a difference far and wide—wherever and with whomever he served, from the Army’s laboratories at Natick, MA, to the vast and varied Army community at Aberdeen Proving Ground, MD, to the forward outposts he helped to equip and protect in Afghanistan. Nothing could make his legacy more clear than the countless tributes following the death on Aug. 5 of the 55-year-old deputy commanding general (CG) of the Combined Security Transition Command—Afghanistan, who was killed by an Afghan soldier while visiting Marshal Fahim National Defense University in Kabul.

Greene, who was involved in preparing Afghan forces for the planned departure of U.S. and coalition troops at the end of this year, was the most senior U.S. military officer to be killed in combat since the Vietnam War. Thirteen NATO and Afghan soldiers were wounded in the Aug. 5 attack. The assailant was killed.

From Greene’s immediate family—his wife, Dr. Susan Myers (COL, USA, Ret.); his daughter, Amelia Greene; his son, 1LT Matthew Greene; his daughter-in-law, Kasandra Greene; and his father, Harold F. Greene, who also served in the Army—and his Army family came memories of a husband, father, son, leader, mentor and colleague who took his duties, responsibilities and challenges seriously but always with a sense of humor.

“He was passionate about his responsibilities to provide our Soldiers with the best equipment in this world,” said the Hon. Heidi Shyu, assistant secretary of the Army for acquisition,

logistics and technology (ASA(ALT)), at a memorial service for Greene Aug. 13 at the Pentagon. Greene had served as her deputy for acquisition and systems management until deploying to Afghanistan in January. “I could count on Harry to make decisions and tackle problems with sound logic and clear perspective on what’s needed, especially on matters that affect our Soldiers,” Shyu said. “I sorely miss his intellect, his talent, his sense of humor and his mentorship.”

## DR. GREENE, ENGINEER

An engineer by training, Greene held five graduate degrees. He received his commission in 1980 through ROTC at Rensselaer Polytechnic Institute, where he received a B.S. in materials engineering and later an M.S. in industrial engineering. In addition, he earned an M.S. in materials engineering, an M.S. in mechanical engineering and a Ph.D. in materials science from the University of Southern California, and a Master of Strategic Studies degree from the U.S. Army War College. His military education also included the Engineer Officer Basic and Advanced Courses, the U.S. Army Command and General Staff College and the Defense Systems Management College’s Advanced Program Management Course.

Greene was particularly passionate about harnessing cutting-edge communications technology to empower and unburden Soldiers. “We’re trying to unburden them, and we’re trying to protect them,” he said at the May 3, 2010, opening of the Social Cognitive Networks Academic Research Center at Rensselaer. “We’re in a fight now with an enemy that’s a little bit different

## THE GREENE SMILE

When people at U.S. Natick Soldier Systems Center (NSSC) think back on then-BG Harry Greene, they remember being greeted with this smile. (U.S. Army photo)



#### READY TO FLY

Then-BG Greene at U.S. Army Yuma Proving Ground, AZ, in 2012. (U.S. Army photo)



#### TRIBUTE TO LEADERSHIP

MG Nick Justice, then-CG of RDECOM, presents a coin map to then-BG Greene during his farewell dinner as RDECOM deputy CG, at Sudbury, MA, May 9, 2011. (Photo by David McNally)

and uses different techniques ... and networks are a key part of that,” Greene said.

“In his 34-year career, Harry was an engineer of technical expertise, business acumen and decisive leadership to the Army,” Shyu said at the Pentagon memorial service, where she recalled a recent trip to Afghanistan during which she asked Greene how he was managing the challenging conditions and hectic pace. “He told me in no uncertain terms, ‘It got me out of the Pentagon,’ and ‘There’s no other place I’d rather be, because I’m surrounded by Soldiers.’”

Army Chief of Staff GEN Raymond T. Odierno, who hosted the memorial service, described Greene as “a Soldier, a husband, a father, a son, a friend, a leader and a great patriot” who “left an indelible mark on everyone he came in contact with.”

“When I think about Harry, I think of a scholar, an inspirational leader, one who was humble and a passionate Soldier, always committed to whatever mission he was given,” he said.

#### THE RIGHT SOLDIER

Odierno said that when he was looking for the right person to establish the multinational mechanisms to sustain the Afghan National Army and Security Force for the long term, he knew Greene was the right Soldier. “He had all the credentials, background, personality and the knowledge to prepare the Afghan Security Forces as U.S. and coalition troops depart. I believe he had a rare combination of intellect, compassion and warrior ethos. He was simply a great man.

“What I’ll always remember about Harry is that he was a true patriot and the epitome of what we hope and expect of our senior leaders—a leader who is



competent, able to do whatever job is given to him and to do it to the best of his ability with commitment to Soldiers, the Army, the nation, the mission, and able to balance that with commitment to his family.”

Well before he deployed to Afghanistan, Greene was the heart and soul behind Army AL&T’s in-depth coverage of the forward-deployed Army materiel enterprise in the magazine’s July-September 2013 issue. Not content to look just at ASA(ALT)’s operations in theater, he asked Army AL&T to profile forward-deployed personnel—military, civilian and contractor—from U.S. Army Contracting Command, U.S. Army Research, Development and Engineering Command (RDECOM) and U.S. Army Medical Command as well, all “doing great things for Soldiers.”

With Greene’s enthusiastic support throughout the planning and execution of the articles, the result was an overview, “It Takes a Team,” by then-COL William E. Cole, who recently had served as acquisition, science and technology adviser to U.S. Forces – Afghanistan and director of ASA(ALT) Forward Operations in Operation Enduring Freedom. Following Cole’s article were eight profiles of forward-deployed personnel, looking at what they did for Soldiers in theater, the rewards and the risks.

### MEANINGFUL IMPACT

But that was just one example of Greene’s unfailing dedication to telling the story of supporting Soldiers with the best equipment available, when and where they need it. True to the positive impact that Greene had wherever he served, more than 1,000 people filled the Post Theater at Aberdeen Proving Ground, MD, Aug. 11 to share memories and tributes to the fallen Soldier, who served at Aberdeen as



### THE HUMAN TOUCH

Then-BG Greene leads the promotion ceremony of then-LTC Alan Samuels on Feb. 4. “It’s an honor for me to do this,” Greene said. “LTC Samuels has demonstrated the potential to lead, and he’s being promoted to a position where we expect him to lead.” Samuels said he was humbled. “The Army for me is a place where, with some hard work and selfless service, you can call it home.” Similarly, Greene was known for his selfless service, and the Army was his home. (U.S. Army photo)



### FAST FRIENDS

The Hon. Heidi Shyu, ASA(ALT), shares a laugh with Greene during a ceremony she hosted marking his promotion to major general, at the Fort Myer, VA, Officers’ Club, Aug. 30, 2012. (Photo by Tom Faulkner, RDECOM)



### READY FOR NEW CHALLENGES

Then-BG Greene prepares to relinquish command of NSSC during a ceremony at Natick, MA, May 10, 2011. (Photo by David Kamm, Natick Soldier Research, Development and Engineering Center)

deputy CG of RDECOM from August 2009 to May 2011 and simultaneously as senior commander of NSSC in Natick, MA. He served again at Aberdeen as the program executive officer for intelligence, electronic warfare and sensors.

Greene previously had served in a variety of staff, acquisition and command positions, including as director of materiel for the deputy chief of staff for programs, HQDA G-8; Battle Command Division chief, Office of the ASA(ALT); project manager for battle command; product manager for the Aerial Common Sensor; and brigade engineer and company commander, V Corps, Federal Republic of Germany.

His awards and decorations included the Distinguished Service Medal, the Legion of Merit with three Oak Leaf Clusters, the Meritorious Service Medal with five Oak Leaf Clusters, the Army Commendation Medal with three Oak Leaf Clusters, the Army Achievement Medal and the Army Staff Identification Badge.

“Life was his fuel, and he energized us all. ... Any one of us could be standing here, telling a unique story about how Harry helped us laugh, helped us grow and made us better people,” said retired COL David Moore during the ceremony at Aberdeen for his former colleague.

“Harry was truly one of a kind,” said Gary Martin, deputy to the CG of U.S. Army Communications-Electronics Command at Aberdeen. “Harry was more than just a bright guy—he was also an extremely effective leader and officer,” Martin said. “He made it easy for people to like and want to work for him.”

Martin recalled that, during his final assignment, Greene woke up at 3 a.m. in Afghanistan to attend, via Skype, a



### ALMA MATER

As deputy CG of RDECOM, then-BG Greene, an alumnus of Rensselaer Polytechnic Institute, speaks at the opening of the Social Cognitive Networks Academic Research Center at Rensselaer, May 3, 2010, in Troy, NY. (Photo by Mark Marchand, Rensselaer Polytechnic Institute)



ceremony recognizing the career contributions of a longtime colleague at Aberdeen. “He wanted to do this so he could personally recognize the individual and to thank him for his years of service to the Army,” Martin said. “That’s how Harry was, and what he meant to people.”

## REMEMBERING A BROTHER IN ARMS

Remembrances of Greene poured forth from across the Army.

Tom Faulkner, RDECOM chief of visual information, photographed Greene for his official brigadier general portrait. “After 33 years working here at [Aberdeen], I’ve met some wonderful people, but few were cut from the same cloth as MG Harry Greene,” Faulkner said. “He was easygoing, had an excellent sense of humor, was never condescending and always made everyone feel welcome. The Army lost a great Soldier who was full of compassion, extremely intelligent and witty, and one that made a lasting impression with everyone he came in contact with.”

At Natick, where he was only a part-time resident, Greene was equally comfortable at a lectern explaining the important work done at NSSC, or taking off his jacket and dropping for push-ups with youngsters at Beacon Hill Day. “One of the things I knew from growing up here as a kid was how patriotic [Massachusetts] was,” Greene said. “I learned to have a deeper appreciation during my time here.”

Now-BG Cole, the current NSSC senior commander, had worked for Greene in the past and remembered his rare combination of intellect, humility, compassion and humor.

“He was extraordinarily smart, cared deeply about his people, and was



## FINAL FAREWELL

A photo of Greene honors the fallen Soldier during a memorial service at the Pentagon’s auditorium Aug. 13. Greene is the highest-ranking service member killed in the wars in Iraq and Afghanistan. (U.S. Army photo by Eboni Everson-Myart)

completely dedicated to the Army’s mission in Afghanistan,” Cole said. “He was also great to work for and with, and he had a super sense of humor. He was a mentor to me, and I will miss him very much.”

“My words can’t fully express the sense of loss, the sadness we share with the Greene family,” Shyu said at the Pentagon memorial service. “We say ‘goodbye’ to our fallen friend. Harry Greene truly lived a successful life as a defining example of generations to follow, and God bless MG Greene, his family he cherished, and the Army he so loved.”

Greene was laid to rest Aug. 14 at Arlington National Cemetery with full military

honors. In lieu of flowers, his family asked that donations be made to a favorite scouting, youth sports or education program. Donations also can be made in Greene’s memory to Fisher House, USO, Wounded Warrior Project, or the Tragedy Assistance Program for Survivors.

## CONTRIBUTORS:

*Claire Heininger*, Program Executive Office Command, Control and Communications – Tactical; *Dan Lafontaine*, RDECOM; *J.D. Leipold*, Army News Service; *Bob Reinert*, NSSC; and *Margaret Roth*, Army AL&T magazine.





## ACQUISITION

# SPOTLIGHT

## MR. RALPH P. "PAT" DeGROODT

### Sailing trip benefits battlefield communications



#### MR. RALPH P. "PAT" DeGROODT

**COMMAND/ORGANIZATION:**

Project Manager Warfighter Information Network – Tactical (WIN-T), Program Executive Office for Command, Control and Communications – Tactical (PEO C3T)

**POSITION AND OFFICIAL TITLE:**

Deputy Product Manager for WIN-T Increment 2

**YEARS OF SERVICE IN WORKFORCE:** 25**AWARDS:**

National Security and International Affairs Medal Finalist, the Samuel J. Heyman Service to America Medals, 2014. Achievement Medal for Civilian Service, 2009

**EDUCATION:**

B.S. in engineering, Widener University

Soldiers communicating on the fly have, in part, the five-year, around-the-world sailing trip that Pat DeGroot and his wife took to thank for the advanced communications options that the Army provides. DeGroot, deputy product manager for the Warfighter Information Network – Tactical (WIN-T) Increment 2, was motivated to work on the system after his trip highlighted the challenges of communicating in remote places without the technology we've come to rely on.

"I grew up sailing and reading books written by the early circumnavigators like Joshua Slocum, [Sir] Robin Knox-Johnston and Sir Francis Chichester," DeGroot said. "Sailing around the world became a life goal at an early age. Around 1995 or so, my wife and I decided we had sufficient sailing experience, and the timing was right in our personal lives to leave on a trip." He and Colleen left from New Jersey in 1998 and returned in 2003, after more than 30,000 miles of sailing.

The trip included stops in remote, uninhabited places like the Chagos Archipelago, a group of atolls in the Indian Ocean. "Most of the time we communicated through ham radio, and it was interesting to see the challenges of communicating without the infrastructure that's commonly in place. It's the same on the battlefield," he said.

For DeGroot, that challenge is one of the things that most people don't know about the work he does. "Rarely do folks outside the military consider the limitations imposed on our Soldiers when they cannot use commercial infrastructure like cell towers and Internet service providers in a country to do their job," he said. "Our technology provides always-on communications without relying on country infrastructure that an enemy could deny the use of or compromise."

DeGroot started in government work with the Navy out of college as an engineering intern and later moved to the Army. "From my first job with the Navy, I have been involved in the acquisition side," he said. In the Army, that means "applying



my engineering knowledge and skills to ensure that Soldier requirements are being met with high-performing, quality products.”

That work has earned him several accolades, most recently selection as a finalist for the Samuel J. Heyman Service to America Medals, awarded annually by the Partnership for Public Service to honor excellence among federal workers. “I didn’t know much about the award until I was nominated, and after I looked into the accomplishments of other finalists, I was very humbled,” said DeGroot. The other nominees “are amazing people, and I’m honored to be a part of that group.”

**What do you do, and why is it important to the warfighter?**

As the deputy product manager for the WIN-T Increment 2, I am responsible for assisting the product manager in the management and direction of a multi-billion-dollar technology and acquisition program. The goal of WIN-T Increment 2 is to bring a communications on-the-move capability to Army commanders and Soldiers. On-the-move technology has significantly changed the way the Army accomplishes command and control, untethering commanders from a fixed location and allowing them to move to locations that afford the most insight and awareness of what is happening in the battlespace. This allows commanders to make informed and correct decisions faster.

From the Soldier’s perspective, on-the-move communication enables continuous connectivity and keeps warfighters safe. They know what is going on around them and are able to communicate their situation continuously. Soldiers in Afghanistan using the system have termed it their “digital guardian angel.”



**IMPROVE, SIMPLIFY**

DeGroot discusses recent simplification improvements to WIN-T Increment 2 with GEN John F. Campbell, then the Army’s vice chief of staff, and LTG Robert S. Ferrell, the Army’s chief information officer/G-6. (U.S. Army photo by Kyle Bond, PEO C3T)

**During your career with the Army AL&T Workforce, what changes have you noticed—in processes, training, equipment, etc.—that have impressed you the most? What change has surprised you the most, and why?**

The biggest single change since I came into the workforce is the introduction of computer and Internet technologies. When I first started, we had a single computer system for an entire directorate and the Web did not exist. Now everyone has the equivalent of several computers, all interconnected and able to communicate. The impact on processes has been dramatic and has significantly increased the pace of government as well as the knowledge base of all our employees.

**Acquisition has changed profoundly in many ways in the past 25 years. How do you see it changing in the future, or how would you like to see it change?**

We have indeed come a long way in the past 25 years. However, I feel most of the progress has come from the application of automation to accelerate the same basic processes we have always used. We

need to radically relook at the ways we approach technology acquisition, particularly in contracting and in the acquisition milestone process, to be more efficient.

The Better Buying Power (BBP) initiative is an example of an area where I believe we have applied new approaches with immediate benefits to programs and taxpayers. By using BBP approaches, we reopened negotiations on one of our contracts and were able to achieve \$220 million in savings over the life of the contract. We were also able to purchase transmission equipment separately, under another contract, saving an additional \$400 million over the life of that contract. Those are significant numbers.

**What’s the greatest satisfaction you have in being a part of the AL&T Workforce?**

My greatest satisfaction comes from the personal and career development of the people I have worked with. I take great satisfaction in their successes and advancement.

—MS. SUSAN L. FOLLETT



### INTEGRATING LESSONS

The Army Network Integration Evaluation (NIE) is a large-scale, semiannual field evaluation of network and non-network capabilities. The U.S. Army Electronic Proving Ground (USAEPG) at Fort Huachuca, AZ, traditionally provides test and evaluation support and instrumentation to NIEs. However, with NIE 14.2, the latest evaluation, USAEPG provided the additional support of a network forensics team that made a positive impact on network troubleshooting, reliability and network protection. Gathering lessons on interactions with the test community, industry partners or units being fielded with a new technology can result in significant benefit to other programs. (Photo by Amy Walker, PEO C3T)



# LESSONS OUTSIDE THE LINES

PEO adds knowledge capture to its arsenal of acquisition tools

*by Mr. Thom Hawkins and Ms. Cheryl McCullough*

**T**here's the good: rallying stakeholders to achieve a 40 percent drop in life-cycle costs for a program moving to sustainment. There's the bad: dealing with changing and unfamiliar requirements and priorities against a backdrop of dwindling budgets and limited resources. And then there's the ugly: catching an unexpected system flaw and pushing the manufacturer to correct it.

Such experiences, familiar to anyone who has spent time in the Army Acquisition Corps, don't always fit neatly into a database. Sometimes we don't even think to categorize them as "lessons learned." But these details are critical to informing our peers and successors about the wide range of challenges we face, various approaches to tackling these issues and the ways we can improve the quality of work across the Acquisition Corps.

That is what prompted the Program Executive Office for Command, Control and Communications – Tactical (PEO C3T) this year to begin a knowledge capture program targeting senior members of the military and civilian workforce who are departing the organization because of retirement or a new assignment. While the exit interview concept is a familiar one across the public and private sectors, our challenge was to turn it into something candid and meaningful—to capture the good, bad and ugly information that would be valuable to the PEO and the Army.

With that mandate, we launched the program in an effort to obtain meaningful content for the Acquisition Lessons Learned Portal (ALLP) managed by the U.S. Army Materiel Systems Analysis Activity (AMSAA). The process also quickly evolved into a mechanism to preserve institutional

knowledge and improve processes within the PEO, especially as we realign the organization to enable network modernization in support of Force 2025. In developing and executing the knowledge capture initiative, we have learned several lessons ourselves about soliciting, preserving and leveraging the expertise of a changing acquisition workforce.

**KNOWLEDGE CAPTURE PROCESS**

By now, all PEOs are in the habit of contributing to the ALLP, a process formalized in a 2012 memo from the Hon. Heidi Shyu, assistant secretary of the Army for acquisition, logistics and technology (ASA(ALT)). Organized by milestones and other significant programmatic events, the database allows program managers and analysts to enter and retrieve information on successes, struggles and lessons learned corresponding to those specific situations. The database is a valuable tool to aggregate information from after-action reviews, facilitating analysis to identify trends that can benefit acquisition programs and policies.

At PEO C3T, we have an additional need to capture and share this kind of information. The organization is undergoing several major changes, with corresponding personnel moves, and is transitioning several programs to sustainment as we pursue new technologies to support the Army’s Tactical Network Modernization Roadmap. So we decided to conduct exit interviews with key leaders. The sessions solicit more robust content for the ALLP database than individuals or programs might otherwise have provided, because the interviews serve as a forcing function for reflection, and because of the broad nature of the questions asked. They collect information on situations that do not necessarily align with a specific milestone yet are still useful to



**DRILLING DOWN**

The knowledge capture process developed by PEO C3T uses a rigorous, structured protocol to obtain information from departing senior leaders and distill it into meaningful content for the ALLP. (SOURCE: PEO C3T)

preserve—such as a risk mitigated or an efficiency found.

PEO C3T’s headquarters Business Management Division (BMD) spearheads the knowledge capture process. The interview team consists of the PEO’s chief of program analysis and the BMD program analyst who covers the interview subject’s portfolio. Thus we have the background and level of rapport to conduct a meaningful discussion, rather than either side just “going through the motions” to fulfill a requirement.

The process begins with the interviewee providing written responses to eight standard questions, structured to elicit wide-ranging yet precise feedback. In addition, the associated program analyst

contributes written prompts for each leader regarding specific challenges he or she has faced, as well as the cost, schedule and performance impacts of those events. A sampling:

- “What are the top five issues that you faced during your tenure, and what steps did you take to avoid the issues, fix the issues or absorb any negative impact from the issues?”
- “Do you feel you had the resources and support necessary to accomplish your job? If not, what was missing?”
- “What changes would you recommend to acquisition policy at any level (Title 10, DOD 5000, AR 70-1)?”
- “Did any particular PEO policies or procedures facilitate or hinder your efforts to manage your programs?”



### TAPPING SUSTAINMENT LESSONS

Soldiers with the 545th Transportation Harbormaster Detachment and the 73rd Signal Company set up the Harbormaster Command and Control Center (HCCC) July 8 at Ford Island, Joint Base Pearl Harbor – Hickam, HI, for the biennial Rim of the Pacific 2014 exercise. HCCC, a mobile and deployable system that can track and communicate with any ship and vessel entering or exiting a particular port within 10 nautical miles, is set to transition to sustainment Oct. 1. PEO C3T plans to expand the knowledge capture program to interview individuals who may not be leaving the organization but possess knowledge in a specific area that’s in demand, such as the transition to sustainment. (Photo by SSG Gaelen Lowers, 8th Theater Sustainment Command)

- “From an acquisition lessons-learned perspective, what advice would you give to your successor? To someone just entering the Acquisition Corps?”

The written responses serve as the foundation for a more detailed discussion during the one-hour, in-person exit interviews, which cover situations and circumstances the key leaders dealt with while working for the PEO. Some lessons identified during this process are tied to specific decision points in the programs’ acquisition life cycles; however, more deal with day-to-day operations, and it may not be immediately obvious that there is a lesson in how the situation or circumstance was handled. That’s where the interviews hold so much value. The program analyst reviews the initial written responses and prepares follow-up questions for clarification. This interaction often uncovers pearls of wisdom that the organization can then capture and share via the ALLP database.

Each interview subject brings a distinct personality to the process: One person

may write lengthy paragraphs and have little to add in person, whereas another might be an expansive conversationalist but offer only generalities on the toughest subjects. Our challenge is to encourage honesty by putting them at ease—the sessions are not recorded, and the content submitted to AMSAA does not have the source’s name attached—and to distill the voluminous input into organized pieces for database entry and consumption by other members of the workforce.

### RESULTS AND PATH AHEAD

While the program is still in the early stages, the knowledge captures thus far have been a rewarding and instructive experience for both the interlocutors and those answering the questions. The effort has increased the amount and quality of information we submit to the ALLP, as well as additional lessons learned that we will distribute within the PEO.

PEO C3T has 48 lessons in the ALLP database; of those, 20 were developed from three interviews conducted in June.

More interviews took place in August, with additional interviews planned.

One such lesson covers a program’s successful sustainment preparation, culminating in a Milestone D-type review with senior leadership that brought together key stakeholders in ASA(ALT) and U.S. Army Materiel Command. The briefing prompted the organizations to make realistic decisions about sustainment plans and costs, leading to formalized, executable agreements and a 40 percent reduction in life-cycle sustainment costs.

That same interviewee provided firsthand experience to encourage identifying data requirements, planning tests to obtain the needed information and capturing this information in the Test and Evaluation Master Plan, as well as leveraging other planned events to overcome data deficits. Another lesson details one project manager’s efforts to engage U.S. Army Contracting Command personnel by inviting them to



**PRESERVING KNOWLEDGE**

BG(P) Daniel P. Hughes, left center, the PEO for C3T, facilitates the assumption of charter for the project manager for mission command (PM MC) from outgoing PM COL Jonas Vogelhut, left, to incoming PM COL Michael Thurston in a ceremony May 30 at Aberdeen Proving Ground, MD. As PEO C3T realigns in support of Force 2025, the knowledge capture program is helping preserve institutional knowledge and improve processes within the PEO, while also providing meaningful content for the ALLP. (Photo by Christopher Rosario, PM MC)

staff calls and hosting joint reviews on contracting documents, with the aim of resolving issues before they escalate to potential “showstoppers.” Neither situation is tied to a program milestone, yet both contain sound advice.

Within the PEO, we are sharing this type of useful content not only with an interviewee’s direct successor (if one exists), but also with others facing similar situations

or working on related subject matter. Lessons related to interacting with the test community, industry partners or units being fielded with a new technology are passed on to other programs that could benefit, regardless of milestone status or acquisition category level.

When a process improvement is reported through a knowledge capture, we will document the efficiency under its proper category (Better Buying Power 2.0, value engineering, etc.) for reporting, dissemination and potential repetition elsewhere in the organization

**CONCLUSION**

In addition to providing valuable insights into their programs, participants in the knowledge capture process have provided constructive feedback on the exit interview process itself. Based on their input, we revised our initial set of questions to build in some additional prompts, following a “situation, impacts, recommendations” structure. The program analysts for each portfolio are also digging deeper to develop more follow-up questions for each leader regarding particular situations that he or she faced.

We also plan to expand the knowledge capture program to interview individuals who may not be leaving the organization but possess knowledge in a specific area that’s in demand, such as the transition to sustainment, or type classification and materiel release. While these technically will not be exit interviews, it is our hope that they will spur reflection, revealing insights and lessons learned that can be disseminated across organizational boundaries.

PEO C3T is also working with AMSAA to move beyond knowledge capture to implementation, developing plans for incorporating lessons into guidance and

policy and proactively seeking solutions to improve the acquisition process.

With the Army’s transformation to a leaner force, the Acquisition Corps inevitably will continue to lose senior personnel. That doesn’t mean we have to lose their perspectives. We believe the knowledge capture program demonstrated at PEO C3T is a productive step toward broader collection, documentation and application of lessons learned throughout the acquisition workforce. With a well-structured process and open-minded participants, any organization can be proactive in identifying the lessons that fall outside the lines.

*For more information, go to: <http://peoc3t.army.mil/> or <http://web.amsaa.army.mil/CAAMLL.html>.*

---

*MR. THOM HAWKINS is the continuous performance improvement program director and chief of program analysis for PEO C3T. He holds a Master of Library and Information Science degree from Drexel University and a B.A. in English from Washington College. He is Level III certified in program management and is an Army-certified Lean Six Sigma Black Belt. He also holds Project Management Professional and Risk Management Professional credentials from the Project Management Institute. He is a member of the Army Acquisition Corps (AAC).*

*MS. CHERYL MCCULLOUGH is a program analyst in the Program Analysis Branch of PEO C3T’s Business Management Division. She holds a B.A. in emergency and disaster management with a concentration in homeland security from American Military University. She is Level III certified in program management and is a member of the AAC.*



CONNECTING TOMORROW'S WARRIORS



# NOT YOUR AVERAGE STATUS UPDATE

**TACTICAL APPS FOR MISSION COMMAND ANYTIME, ANYWHERE,  
WITH ANY TEAM AND ON ANY DEVICE.**

New Project Manager Mission Command unites command post and platforms.

Software Development Kits leverage Android and Ozone.

Government and industry partners create new apps.

Processes support agile capability development, assessment and delivery.

Unified data enables improved vertical and horizontal integration.

Software and hardware support the Common Operating Environment.



PROGRAM EXECUTIVE OFFICE COMMAND CONTROL COMMUNICATIONS-TACTICAL

# GROUND TRUTH

Lessons learned in the Army Acquisition Workforce

by Ms. Jen Adair

**T**he Army Acquisition Workforce is essential to the success of the best-trained, best equipped and best-led fighting force in the world: the U.S. Army. The knowledge, professionalism and dedication of these Army acquisition professionals enable our Soldiers to dominate the battlefield. To document and share these experiences and knowledge, the acquisition workforce has been submitting lessons learned to the Army Acquisition Lessons Learned Portal (ALLP). The ALLP, championed by the Army acquisition executive and deployed in October 2012, is a knowledge management tool that aims to enhance the performance of the Army acquisition enterprise and influence Army acquisition policies, planning and decisions. Following is a sample of lessons from the ALLP related to the acquisition workforce.

## **WORKFORCE MANAGEMENT AND COMMUNICATION**

**LL\_111: Management must actively engage the engineering workforce and the user community and seek their input and advice.**

### *Background*

Communication is one of the most important responsibilities of any program or project manager. Most of his or her time will be spent communicating, which facilitates collaboration and reduces inefficiencies. Concurrent engineering, collaborative design, systems integration, systems engineering and high-performance



### **WHAT DID YOU SAY?**

Open communications with the workforce are essential for a successful and proficient organization. (Image by Matt Trommer/iStock/Thinkstock)





### CROSSING CULTURES

CW3 Bobby Sattazahn from the 173rd Infantry Brigade Combat Team (Airborne) purchases fruit from a local vendor during Central Accord 2014, a combined joint training exercise held in Cameroon and designed to sustain tactical proficiency, improve multi-echelon operations, and develop multinational logistical capabilities in an austere forward environment. Lessons learned indicate that using native language and observing cultural norms are predictors for mission success. (U.S. Army photo by SPC Jacob Hamby)

work teams depend on fluid communication between teams, individuals, contractors and customers or clients. It is not enough that communication take place; the communication must be effective. Be aware of the barriers to and facilitators of communication. Use clear and concise communication, as well as active listening.

#### *Recommendation*

Management must actively engage the engineering workforce and the user community and seek their input and advice. Those in management must take care not to lose touch with the information grapevine: peer-to-peer information flow

at the design and user working level. Even those with the best of intentions to stay connected to their former colleagues must take note that a managerial position elevates an individual above the day-to-day, word-of-mouth conversation about what is working and what is not. Those actively engaged in solving design issues have firsthand information about what is and is not effective, so it is advisable to pay attention to their concerns. Often, communication flow is hindered by a belief that management knows better than those in the trenches. And often, when input is sought from management, the response is not acknowledged.

---

**LL\_530: Avoid waste and confusion by keeping the workforce up to speed when it comes to program changes, through proactive analysis and information dissemination.**

#### *Background*

Dissemination of information was a continual problem. A better way was required to keep the workforce informed regarding program changes. Many times, personnel wasted time and resources by working from outdated information. The method used to mitigate this problem must be available to all required workforce personnel, possibly with differing

access tailored to their role or need-to-know status. Rotational schedules must also be supported.

*Recommendation*

Hold a weekly leadership brief (maximum half an hour) to update the workforce on relevant changes, updates or schedule shifts based on Council of Colonels or in-process review meetings. Proactively adjust the information dissemination process when inefficiencies are identified through troubleshooting analysis or are otherwise witnessed and reported. Employ SharePoint-based tools.

**WORKFORCE TRAINING**

**LL\_642: The execution of an internal program to train and develop interns will significantly enhance the overall effectiveness of the command, as well as build future workforce expertise.**

*Background*

The Program Executive Office for Simulation, Training and Instrumentation (PEO STRI) established the Acquisition Academy (A2) in 2008 to grow its own talent and to combat a declining contracting population. A2 is an 11-week, multidisciplinary program designed to develop interns' knowledge and skills in preparation to join the workforce and contribute as valued members.

*Recommendation*

PEO STRI hires interns to meet its ever-demanding mission requirements. These individuals will be the future leaders of PEO STRI or possibly other commands. A2 aims to successfully grow the acquisition workforce, developing leaders and providing the best simulation, training and instrumentation products and tools to the warfighter. Use of such a program in any PEO will help ensure that the future workforce has quality, educated and motivated personnel.

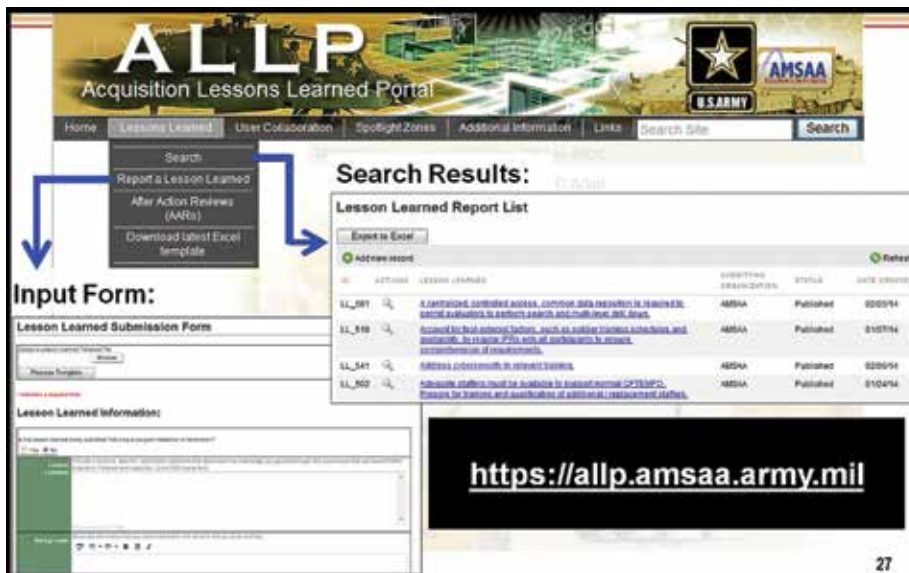

**RESEARCH TOOL**

The ALLP is the authoritative source of relevant and timely acquisition lessons learned. This figure shows how to input and search to retrieve lessons and best practices. (Image courtesy of AMSAA)



**PERFECT FIT**

Soldiers with 2nd Platoon, 244th Engineer Company, Maryland Army National Guard measure their work during repair of the Leadership Reaction Course at Gunpowder Military Reservation in Glen Arm, MD, Aug. 9. Data collected from the ALLP indicate that management must actively engage the engineering workforce and the user community and seek their input and advice. (Photo by SSG Nancy Spicer, 29th Mobile Public Affairs Detachment)



**GROUP EFFORT**

The Army Acquisition Lessons Learned Team consists of six members. In top row, from left, are Kevin Guite, Gail Cayce-Adams and Harry Reed. In bottom row, from left, are Ruth Dumer, Jen Adair and Jill Iracki. (Photo by James W. Foard, Aberdeen Proving Ground)

**LL\_53: Key personnel should be trained in status-of-forces agreements and host nation laws and regulations.**

*Background*

Contracting strategies and budgets were built on practices inconsistent with the Kuwait Labor Law, leading to inefficiency as a result of unclear policy and legal risk mitigation.

*Recommendation*

Ensure the promulgation of clear and consistent policy (through Army Knowledge Online or the U.S. Central Command policy repository) to require that key personnel be trained in status-of-forces agreements and host nation laws and regulations, and make sure industry is sufficiently aware of the policies.

**LL\_415: International acquisition teams should be trained and equipped with cultural skills relevant for their programs. Leverage available DOD resources to help with cross-cultural acumen.**

*Background*

Cross-cultural acumen is vital to most international programs. Failure to account for cultural differences makes it difficult to establish the trust and credibility needed for such an effort.

*Recommendation*

Like the operational community, our international acquisition teams should be trained and equipped with cultural skills relevant to their programs. There are many resources within DOD that teams can leverage to help with developing cross-cultural acumen.

**LL\_488: Require awareness training of cultural norms and basic greetings for civilians and warfighters.**

*Background*

The Afghanistan Virtualization Project demonstrated that the most successful quality assurance engineers were those who were able to relate to the local national employees using their native language and observing their cultural norms.

*Recommendation*

Observance of norms and use of language should be critical skills for those who interact with local national employees.

**LL\_715: A jointly trained team, and advance research and planning among team members, result in an efficiently run integrated baseline review (IBR).**

*Background*

The Integrated Air and Missile Defense Project Office conducted joint IBR and earned-value management training and developed pre-IBR questions and control account manager briefing slides to contribute to IBR success.

*Recommendation*

Use available resources to conduct professional and value-added training. The Defense Acquisition University-led “Joint Integrated Baseline Review” training was very effective in encouraging open communication, which was crucial for conducting a successful IBR. In addition, the training was conducted at no additional cost to the government.

*MS. JEN ADAIR is an operations research analyst with the U.S. Army Materiel Systems Analysis Activity, Aberdeen Proving Ground, MD. She holds an M.S. in operations research and project management from the Florida Institute of Technology and a B.S. in computer science from Towson University. She is Level II certified in engineering.*

# TRAIN *to* SUSTAIN

Interactive multimedia instruction uses lifelong learning methodologies to support battlefield communication systems

*by Mr. Peter Nesby*



## **HANDS-ON TRAINING**

Students at Fort Benning, GA, access ViewSAT software to acquire the satellite network. The structure of the CSS training, from familiarization to validation, ensures that students are ready to handle real systems. (Photo by Linda Valenzano)

**T**he product director for Defense Wide Transmission Systems (PD DWTS) is using interactive multimedia instruction (IMI) to enhance sustainment training for key battlefield communication systems.

IMI employs computer-based technology integrating a host of components, including text, graphics, animation, sound and video. IMI training applications can take many forms, including tutorials, simulations, virtual reality and expert systems, as well as “just-in-time” training embedded in performance support systems.

PD DWTS, assigned to the Program Executive Office for Enterprise Information Systems, recently launched a training support package using distributed learning to support new equipment training and unit sustainment training for the Combat Service Support (CSS) Automated Information Systems Interface (CAISI) and CSS Very Small Aperture Terminal (CSS VSAT) systems.

CAISI allows current and emerging battlefield CSS automation devices to exchange information electronically through tactical networks, interfaces with other battlefield and sustaining-base automated systems. It provides unit commanders and logistics managers an interface device to support CSS doctrine for full-spectrum operations. This capability supports geographically separated groups of users and the transfer of real-time information in both fixed and mobile operating environments.

CSS VSAT provides a highly effective, satellite communications-based solution to CSS nodes, and supports information

exchange up to the sensitive information level. The system is easy to use and transport, can be deployed rapidly anywhere in the world and is fully integrated into the Non-secure Internet Protocol Router Network (NIPRNet) segment of the Global Information Grid.

Both systems have concluded total package fielding. The need for the IMI materialized when it became clear that fielding would end and personnel would rotate out of the units, taking with them the knowledge they had gained in training. Incoming Soldiers needed this critical training for sustainment and to prepare for upcoming deployments, future conflicts and contingencies.

**LIFELONG LEARNING FOCUS**

IMI provides virtual learning and simulation products that eliminate training gaps while reducing hands-on training time, creating a safe, realistic yet forgiving environment in which to exercise challenging scenarios and learn from mistakes. Thus operators can understand how their roles and functions fit into the mission scope.

The IMI for CAISI-CSS VSAT aims to support and sustain the skills of Army personnel using these systems so that they can perform their jobs to competence standards set forth by the U.S. Army Training and Doctrine Command (TRADOC).

PD DWTS used the U.S. Army Learning Model for 2015 (ALM 2015), TRADOC regulations, and Sharable Content Object Reference Model (SCORM) specifications from the Advanced Distributed Learning Initiative to develop its IMI sustainment training package. ALM 2015 is a continuous adaptive learning



**NET BENEFIT**

Students at Fort Carson, CO, connect the antenna feed boom cable to the antenna pedestal cable on a CSS-VSAT during new equipment training. Virtual learning reduces hands-on training time with actual equipment, and creates a safe, realistic yet forgiving environment in which to exercise challenging scenarios and learn from mistakes.

(Photo by Kelly McCoy)



**COMMUNICATIONS ENABLERS**

Two CSS VSATs and a CAISI outside a 4th Infantry Division sustainment automation support management office at Camp Buehring, Kuwait, provide full-spectrum communication solutions. IMI training familiarizes students with the systems before they ever lay hands on them. (Photo by CW2 Daniela Davies)

model for the 21st-century Soldier, instilling competencies in a learner-centric environment.

“The future of IMI will become even more important with the U.S. Army transforming its training approach to focus on lifelong learning,” said Yolanda Moorhead, DWTS training, evaluation and documentation manager. The CAISI-CSS VSAT IMI marks a major shift from the classroom environment to the

development and support of distributed learning, and its SCORM compliance means it can run on any personal computer or laptop via download from the CSS Communications website at <https://peoeis.army.mil/csscomms/Pages/csscomms.aspx>.

To remain competitive, the Army must use technology to engage and appeal to learners in the digital age while allowing seasoned professionals to strengthen

their skills. PD DWTS is at the forefront of ALM 2015, preparing Soldiers to be technically and tactically proficient, and to think critically, make sound decisions, interact across cultures and adapt quickly to rapidly evolving situations.

**DEVELOPMENT APPROACH**

The IMI for CAISI-CSS VSAT reflects a “tell me, show me, try it” interactive approach, adopting TRADOC’s “four modes of learning” methodology. The four modes are:

**Familiarize**—Lessons serve primarily as a “push” of information from the system to the user. As the user proceeds through the training content, there is no way to fail a specific step. Progressing through familiar content provides very little interactivity between the simulation system and the user. In most cases, the user’s input is limited to clicking on a button in the user interface to proceed to the next step. This learning mode corresponds to the “tell me” phase.

**Acquire**—Lessons help the learner discover how to accomplish a task. This discovery can include a sequence of actions, interaction with objects, the use of tools required to perform such interaction, and any expected responses of objects or subjects. In these lessons, the simulation training user interface displays a sequence of steps that the user must perform successfully before continuing to the next step. Learners struggling with a specific step receive graduated feedback that becomes more specific with each failed attempt. This mode is designed to prevent the learner from skipping steps or performing them out of sequence.

Acquire lessons provide significantly more interactivity than familiarize lessons. In acquire mode, IMI content allows the user to interact with the 3-D

environment by navigating within the space; selecting and identifying objects or components; interacting with knobs, buttons and controls; observing object or component responsive behaviors; and receiving simulation system feedback. This learning mode incorporates all facets of the tell-me, show-me, try-it approach.

**Practice**—Lessons provide the learner with a means to test his or her performance. As with the acquire mode, practice lessons provide sequential steps that the learner must perform successfully and in the correct order to continue. However, during a practice lesson, the simulation system tracks unsuccessful attempts to perform each step. The system provides graduated feedback and contextual hints if a learner struggles with a specific step; these become more specific with each failed attempt. On the third failed attempt at an individual step, the step is marked as failed and the full text of the step is provided. The user must complete the step successfully to continue the training. Failure of any individual step in a lesson results in failure of the entire lesson. Upon completion of the practice lesson, an after-action review allows the learner to review his or her performance.

Practice lessons provide interactivity similar to that of lessons in the acquire mode, but require additional training logic such as contextual hints and pass/fail tracking. This learning mode integrates the tell-me and try-it approaches.

**Validate**—Lessons provide the learner with a virtual-reality task training experience. As with acquire and practice lessons, this mode requires the learner to perform steps successfully and in sequence. However, unlike with acquire and practice lessons, a learner struggling with an individual step receives no

SYSTEM	POSITION	TYPE	GROUP		
CSS VSAT 1.2M-E and CAISI	User	VSAT Operator NET	System Overview		
			CAISI Operator NET		
			CAISI System Support Representative		

LESSON	FAMILIARIZE	ACQUIRE	PRACTICE	VALIDATE
Introduction to CSS VSAT 1.2M-E System Overview	GO			
CSS VSAT 1.2M-E Cases Overview Part 1	GO			
CSS VSAT 1.2M-E Cases Overview Part 2				
CSS VSAT 1.2M-E System Assembly Part 1		40% Complete	Not Attempted	Not Attempted
CSS VSAT 1.2M-E System Assembly Part 2		Not Attempted	Not Attempted	Not Attempted
CSS VSAT 1.2M-E System Assembly Part 3		Not Attempted	Not Attempted	Not Attempted
CSS VSAT 1.2M-E System Interface Devices Overview	Not Attempted			
VoIP Phone Overview	Not Attempted			
VoIP Phone Unpacking and Setup		Not Attempted	Not Attempted	Not Attempted

**DESCRIPTION**

Training on assembly procedures for the Combat Service Support Very Small Aperture Terminal 1.2Meter-Enhanced (CSS VSAT 1.2M-E).

**PREVIEW**

#### LESSON PLAN

This screenshot of the VSAT Lesson Manager shows the status of each lesson by mode, following TRADOC's four modes of learning. (Image courtesy of TRADOC)



#### BASIC TRAINING

This screenshot illustrates a CAISI acquire lesson, instructing the user how to properly connect the radio frequency cable to the directional grid antenna. Acquire lessons incorporate all facets of the tell-me, show-me, try-it approach. (Image courtesy of TRADOC)

graduated feedback or hints. Upon the third unsuccessful attempt at an individual step, the step is considered failed, as is the lesson. No further information is provided to help the learner complete the step. If the learner cannot successfully complete a specific step, he or she is unable to continue the lesson. Typically, validation lessons are designed with a certain time allowance for completion. If the learner becomes stuck on a step and is unable to continue, the lesson will end with a time violation and will be considered as failed.

Validate lessons provide the most interactivity of the four learning modes, as well as the most complex training logic. This learning mode focuses primarily on the try-it approach.

**CONCLUSION**

According to LTC Jeff Etienne, product director for DWTS, “the IMI is a 21st-century gaming gateway to sustainment training of the force on CSS VSAT and CAISI. It is the future portal of technology for sustainment training anywhere in the world, 24/7, 365.” Ideally, IMI will augment the Army’s “train the trainer” concept, providing continuity and reinforcing required skill sets for deploying and operating CAISI and CSS VSAT systems.

“From a software developer aspect, when creating the IMI and talking with Soldiers during the development process, there are not a lot of tools for the Soldier that can replace hands-on training,” said Joseph Tzoumis, DWTS instructor and fielder, who assisted in developing the IMI for CAISI-CSS VSAT. “But the IMI comes very close, as it provides the lesson content in an interactive virtual environment when they are deployed, just as if they were in the classroom.”

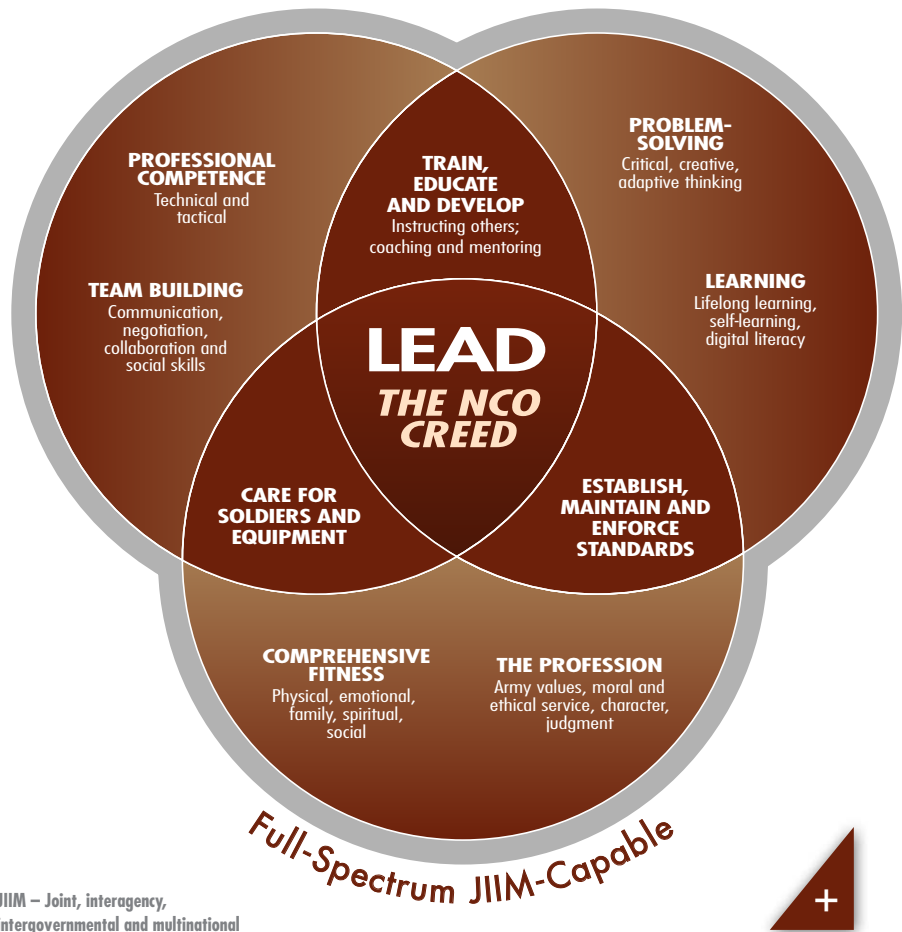

JIIM – Joint, interagency, intergovernmental and multinational

**ARMY LEARNING MODEL 2015**

ALM 2015, a continuous adaptive learning model for the 21st-century Soldier and the basis of PD DWTS’ approach to developing IMI, illustrates desired objectives and activities. (SOURCE: TRADOC)

PD DWTS is matching the digital capabilities of CSS systems with gaming technology, using virtual reality simulations delivered over the Internet. Ideally, the training NCO will download the program within the unit and install it for use by incoming Soldiers. Upon completion, Soldiers can deploy and operate both systems in garrison exercises and in theater, executing the logistics mission of the Army deputy chief of staff, G-4.

For more information, contact the author at [peter.l.nesby2.civ@mail.mil](mailto:peter.l.nesby2.civ@mail.mil).

MR. PETER NESBY is the project lead for Combat Service Support Satellite Communications, under PD DWTS. He holds an M.S. in computer information systems from Strayer University and a B.S. in professional studies/computer technology from the University of Mary Washington. Before becoming a government civilian, he served in the Air Force and the Army. He is Level III certified in both program management and information technology, and is a member of the Army Acquisition Corps.



*proudly*

# Fielding to our Men & Women in uniform. since 1987



1990

**1991-95:** PEO supports Operations Desert Shield and Desert Storm.

Joint STARS Ground Station Module deployed to Desert Storm.

Firefinder AN/TPQ-36/37 V8 fielded.

ARL fielded to Korea.



2000

**2003-08:** PEO supports OIF/OEF and GWOT operations.

Lifesaving, quick reaction capabilities include Duke CREW systems, Common Missile Warning System, TF ODIN, BETTS-C.

DCGS-A V2 fixed/V3 fielded.

Persistent Threat Detection System fielded.



2010

**1988:** Worldwide fielding of General Purpose (PVS-7) and (AVS-6) Aviator Night Vision Goggles. Trailblazer, Teammate and Quickfix COMINT Systems fielded.

Initial Guardrail Common Sensor system fielded to Korea.



**1996-2002:** 2GenFLIR for M1s and Bradleys delivered.

Sentinel Radar fielded.

PEO takes oversight of JTUAV and Navigation Systems.

DVE and Common Ground System fielded worldwide.

GR/CS 2000 rollout.

Prophet fielded to BCT.



**2009-Today:** ISR surge support.  
Prophet Enhanced fielded.  
Guardrail Baseline systems fielded.  
Enhanced Medium Altitude Reconnaissance Surveillance System delivered.  
Developing Assured Positioning Navigation and Timing, Common Infrared Countermeasures.  
Overseeing Command Post CE and Sensor CE.  
Designated DOD Single Manager for ground CREW, the Army interface to the Tactical Exploitation of National Assets.

PEO

IEW&S

Intelligence, Electronic Warfare & Sensors

PEO IEW&S provides affordable, world-class sensor and electronic warfare capabilities enabling rapid situational understanding and decisive action.

<http://peoiews.apg.army.mil>

Find us on



## LOGISTICS



# SPOTLIGHT

## MAJ JAMES A. "TONY" LINDH II

### Combining different viewpoints for better analytics

#### MAJ JAMES A. "TONY" LINDH II

##### COMMAND/ORGANIZATION:

Project Manager for Army Enterprise Systems Integration Program, Program Executive Office Enterprise Information Systems (PEO EIS)

##### POSITION AND OFFICIAL TITLE:

Assistant project manager, Army centralized business analytics

##### YEARS OF SERVICE:

4 years in the workforce, 14 years of military service

##### AWARDS:

Bronze Star Medal, Meritorious Service Medal, Army Commendation Medal, Army Achievement Medal, Meritorious Unit Commendation, National Defense Service Medal, Iraq Campaign Medal Campaign Stars, Global War on Terror Expeditionary Medal, Global War on Terror Service Medal, Army Service Ribbon, Overseas Service Ribbon, Combat Action Badge, Parachutist Badge, Parachute Rigger Badge

##### EDUCATION:

M.S. in project management, University of Alaska Anchorage; B.S. in biomedical sciences, Montana State University – Bozeman

**M**AJ James "Tony" Lindh II might be part of the acquisition workforce, but "technically, I am and will always be an Army logistician," he said.

Lindh started his logistics career as a quartermaster officer at Fort Hood, TX, and has since served as a supply platoon leader, a supply and services officer, a security and plans officer, and the deputy in a support operations shop. He served in Iraq as a battalion S4 (essentially a battalion's logistics officer), a material readiness officer and a field maintenance company commander, and was most recently a rear detachment commander before moving to acquisition four years ago.

He's now the assistant project manager under the product director (PD) for the Army Enterprise Systems Integration Program (AESIP) Hub and is leading the Army Centralized Business Analytics (ACBA) project. "PD AESIP Hub is building out the ACBA to aggregate data from multiple enterprise resource planning [ERP] and non-ERP systems, as well as business warehouse systems,

into a single environment for enterprise reporting and dashboards," he explained, "allowing users a streamlined, cross-program view of data from a single access portal."

His biggest challenge? "Communicating with our numerous stakeholders in order to refine requirements to the point where my developers can build the best product to exceed expectations," he said. "We have to bridge the gap between the technical—software and reporting technology tools—and functional. This is similar to many other projects, but our gap is unique in that functional folks can't rely on their years and years of legacy knowledge to give us requirements. They are developing and learning a new way of doing business at the same time they learn new software."

That work has its payoffs, Lindh said. "The biggest reward is working with the large breadth of stakeholders from multiple domains and agencies, from AMC [U.S. Army Materiel Command] to DA G-3, in order to build their understanding of the ERPs and the reporting technology in SAP Business Objects



[software] that the Army has already purchased. This will lead to better and better requirements and potentially new trading partners, in order to build our data foundation to deliver more robust reports and eventually one version of the ‘truth.’ ”

Lindh concluded, “Every project and program must deliver something to make our force better. Providing decision-makers and Soldiers at all levels with better reporting and analytics will lead to a more efficient and effective force.”

**What do you do, and why is it important to the Army or the warfighter?**

We are building an enterprise business intelligence system for the Army. ACBA uses SAP Business Warehouse and SAP Business Objects to combine data from multiple ERP and legacy sources to present senior leadership with the most accurate and relevant information they need to make informed decisions, based on equipment readiness, logistics and supply chain metrics, all tied with financial information. The possibilities for reporting and information for key decision-makers are limited only by the data that we have available. We are currently focused on logistics and financial data, but have the technology to combine data from almost any source in the future. This will all be driven by report requirements and will become more tangible to senior leaders after we build the data foundation.

**What’s something that most people don’t know about your job? What surprises outsiders most when you tell them about your job?**

Most of my peers are surprised at the rates that some of the software engineers, developers and architects command. We have a small team and therefore must do our best to attract the best technical folks

**“MY GREATEST SATISFACTION IS THAT I’VE FOUND A WAY TO GIVE BACK TO SOLDIERS AND BUILD COMBAT POWER OUTSIDE OF THE OPERATIONAL ARMY.”**

for the job while minimizing travel costs (one of my personal initiatives). This means we pay a bit more for “A Team” folks, but in the end I believe this saves a significant amount of money and the end product is remarkably better.

**During your career with the Army AL&T Workforce, what changes have you noticed—in processes, training, equipment, etc.—that have impressed you the most? What change has surprised you the most, and why?**

I’ve noticed a significant effort expended on Better Buying Power initiatives, specifically on new contract actions. These efforts have encouraged increased collaboration with our contracting office to streamline the briefings and documentation required. This allows us to decrease the time to award as much as possible while still delivering the best value to the government. We get our contracting folks involved as early as possible, and the outcome has been awesome.

**What’s the greatest satisfaction you have in being a part of the AL&T Workforce?**

My greatest satisfaction is that I’ve found a way to give back to Soldiers and build combat power outside of the operational Army. The Acquisition Corps is still about

taking care of people, but with the added responsibility of taking care of people’s money. I especially enjoy challenging my project team to find innovative ways to cut costs and become more efficient and proficient while delivering maximum benefit to Soldiers.

**Acquisition has changed profoundly in many ways in the past 25 years. How do you see it changing in the future, or how would you like to see it change?**

I believe that we have to get more efficient at how we plan for and award future work. In the ERP business, we rely heavily on contractor expertise to develop and manage the commercial off-the-shelf software, and we spend a lot of time and effort navigating the bureaucratic hurdles required to award large-sum efforts. I know that our Corps will continue to find creative ways to control costs and reduce timelines for awards, but I’m concerned by our lack of young talent to carry the torch. We don’t appear to be attracting and hiring young and talented individuals to grow these skills in-house. If we intend to do more with less, we will absolutely need to attract and retain young talent.

—MS. SUSAN L. FOLLETT

# FORGING NEW LINKS



With Supply Chain Transformation initiative, Army Materiel Command seeks greater efficiencies, better communication

*by Mrs. Jamie Miller*

**I**t's a new era for Army supply chain management. We are looking for more efficient ways to improve the end-to-end management of spare parts, from supplier to Soldier, for the Army's combat systems. The U.S. Army Materiel Command (AMC) has a challenge to stay relevant and shift from a reactive war environment to a proactive drawdown environment of managing and resolving supply chain issues before they become problems.

Starting in 2003, the Army began implementing the Logistics Modernization Program (LMP), an enterprise solution that integrates supply chain, maintenance, repair and overhaul planning and execution. LMP has a user base of more than 20,000 people and incorporates more than 70 DOD systems to plan, make, deliver, repair and return equipment to Soldiers. The shift from

AMC's old requirements determination program, which dated to the 1960s, to the new SAP software product presented challenges for the Army's supply chain managers.

More significant than the issues with the data conversion, however, was finding out that some of our old business processes would no longer work now that every business area "talks" to the others in the new system. Our old processes operated in silos, and we lacked communication and planning across business areas. We were also accustomed to transaction-based thinking (making a decision) instead of analysis-based thinking (why we make decisions). Now we understand the importance of why we make those transactions and what effects they will have throughout other supply chain business areas. AMC has thus taken a more enterprisewide approach to resource planning,



### HEAVY LIFTING

SFC Jean Lacroix, 10th Sustainment Brigade ground movement NCO-in-charge, supervises a forklift operator as he repositions a container June 26 at Bagram Airfield, Afghanistan. AMC's Supply Chain Transformation Team developed a supply chain strategy and a human capital strategy to mitigate supply chain risks such as excess inventory, ineffective and inefficient inventory management practices and inaccurately forecasting demand for spare parts. (Photo by SFC Luis Saavedra, 10th Sustainment Brigade Public Affairs)

analysis and integration of supply chain management processes.

Since 2005, the U.S. Government Accountability Office (GAO) has said that DOD's supply chain management is a "high risk" area needing transformation. Most recently, a 2013 GAO report mentioned problems with excess inventory, ineffective and inefficient inventory management practices and inaccurately forecasting demand for spare parts. In response to the report, AMC created a Supply Chain Transformation Team that developed a supply chain strategy and a human capital strategy to mitigate those risks. These strategies will help to increase supply chain efficiencies, enhance key skills and improve communication within the workforce and throughout the supply chain. The transformation team has made substantial

progress toward these goals with efforts in sales and operations planning, strategic sourcing and supplier relationship management, demand planning and metrics.

### SALES AND OPERATIONS PLANNING

The life-cycle management commands, which include the U.S. Army Aviation and Missile Command, Communications and Electronics Command, Joint Munitions Command, and TACOM Life Cycle Management Command, are participating in AMC's sales and operations planning (S&OP) process. The goal is to leverage best practices from industry to integrate individual business processes (i.e., demand planning, supply planning and resource balancing) in areas of enterprise-level decision-making on supply chain management.

S&OP allows the key stakeholders—from the item managers to weapon system directors all the way up to the logistics center directors and senior leaders at AMC—to collaborate and review metrics from financial projections, forecasted demand plans and supply execution plans at the individual item level or aggregate levels for weapon systems and commodities. The reports from the Enterprise Sales and Operations Planning Tool (ESOPT) help to illustrate aggregate demand and supply plans for entire weapon systems and to evaluate the feasibility and, eventually, the performance of those plans.

Each month, in place of the old "due diligence" reviews, each life-cycle management command holds S&OP internal reviews in preparation for the management business review with

FIGURE 1

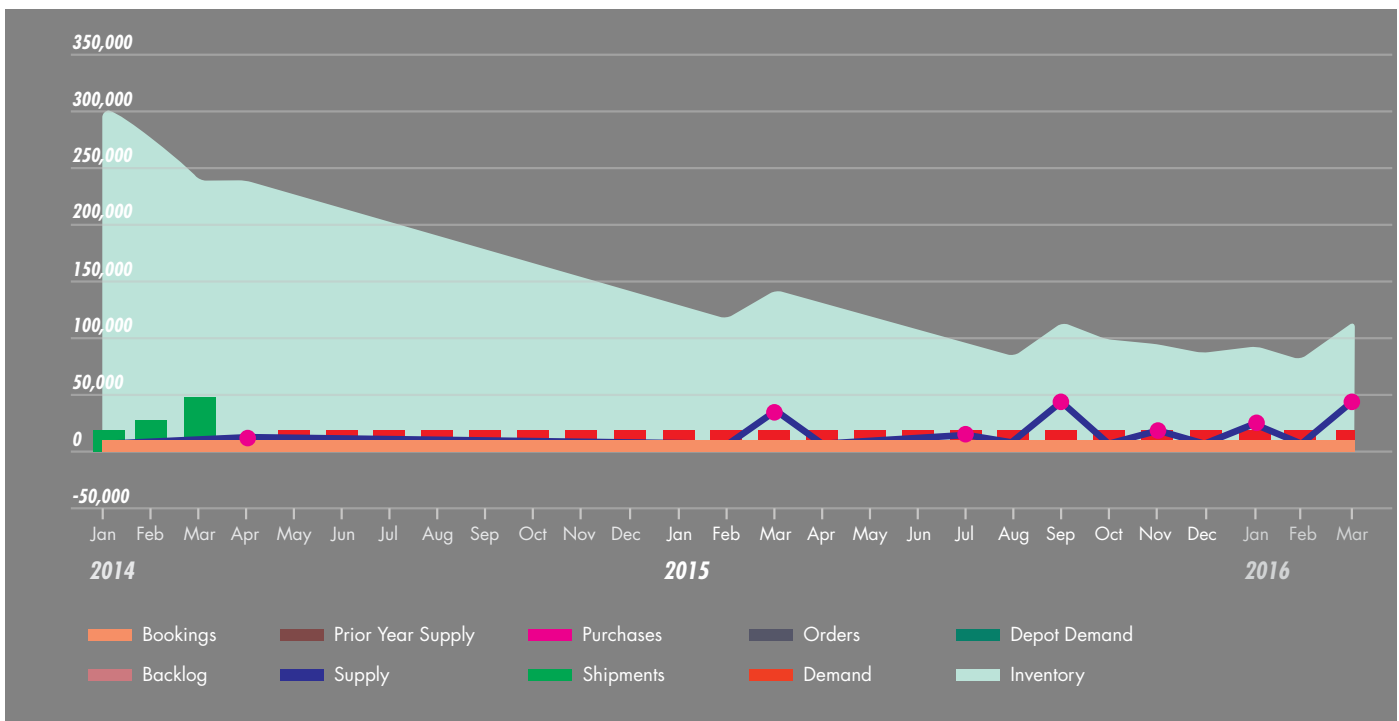

**S&OP ANALYSIS**

As an example of S&OP analysis, this notional graph, created using ESOPT, shows inventory levels declining, shipments coming in, forecasted demands, and a supply plan for the future. (SOURCE: HQ, AMC G-3/4 Secondary Items Requirements Branch)

senior supply chain leadership at AMC. The meetings allow participating commands to discuss anticipated changes in future requirements as well as resource constraints. As budget cuts, inventory reduction goals, new equipment fielding or unforeseen events arise, these management reviews lead to decisions to mitigate potential supply chain risks in the future.

S&OP is an intensive planning and review process, not just a software tool as initially thought. As users become more familiar with ESOPT, it is clear that S&OP is in fact a process to analyze the supply position and assess demand levels, then integrate them financially. The tool is just a means to visualize the business

process. For example, it can produce a graph showing inventory levels decreasing, shipments coming in, forecasted demands and a supply plan for the future. (See Figure 1.)

**STRATEGIC SOURCING AND SUPPLIER RELATIONSHIP**

The Supply Chain Transformation Team established a strategic sourcing and supplier relationship management (SS/SRM) initiative to coordinate the AMC logistics centers and be a single face to the industrial base while building relationships with sole-source suppliers.

Historically, the Army has procured spare parts with limited communication with other partners in the supply chain. SS/SRM



provides better value and supply chain performance by establishing relationships with sole-source suppliers to create open dialogue and synergy. Relationship strategies may differ depending on the supplier; however, common components include contracting (number of contracts and key terms), logistics (e.g., lead times and delivery issues), and information flows (creating appropriate communications channels). Ultimately, SS/SRM promises to lower the cost of material, reduce production lead times and improve product support to the warfighter.

AMC is developing the SS/SRM program to span various Army secondary part suppliers as opportunities arise. It is imperative that we identify opportunities for participation from across the AMC enterprise of logistics centers, and institutionalize the program as a standard business practice. Previously, AMC was not organized for enterprise coordination with suppliers, and collaborating across logistics centers (e.g., through enterprise contracts) rarely occurred. AMC overcame this challenge by creating a representative governance structure—including leadership from each of the logistics centers, HQ, AMC and U.S. Army Contracting Command—to guide SS/SRM activity.

### SUPPLY CHAIN METRICS

Metrics are essential to performance improvement and thus to the success of any supply chain program. We get what we measure. AMC also faces an increasingly complicated challenge of meeting its mission requirements in a fiscally constrained environment. LMP was the first step in linking the data used to measure supply chain processes into one system. However, the logistics centers were still reporting nonstandardized metrics in manually intensive processes that were organizationally and systemically

**FIGURE 2**

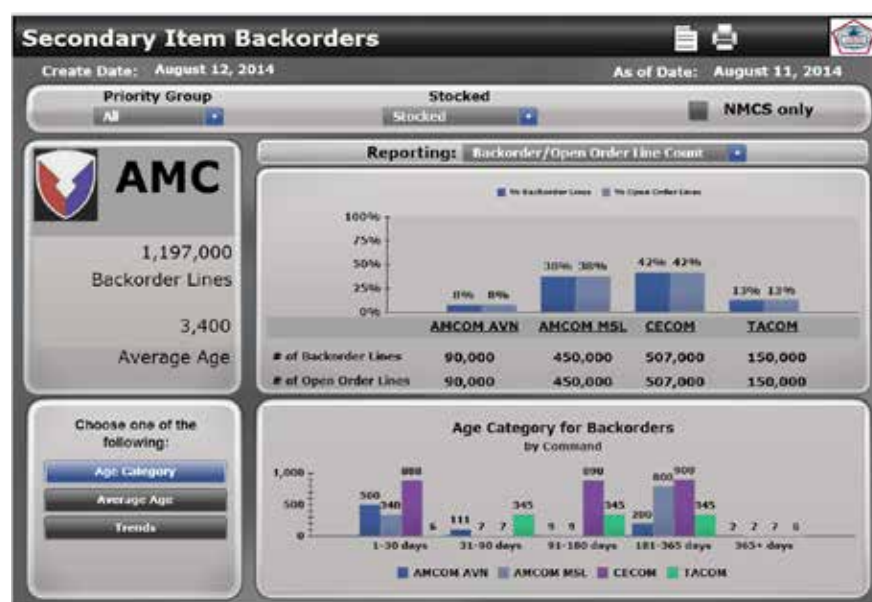

### DATA BOARD

A dashboard system developed by AMC’s Logistics Support Activity (LOGSA) for metrics analysis produced this example using notional data. (SOURCE: LOGSA)

isolated. These obstacles hindered the centers’ ability to report a true, timely and actionable picture of secondary item supply chain performance.

Data analysis on parts of the supply chain was available; however, it came from different commands with inconsistent methods of data extraction, sources and analysis. Creating and implementing a single solution for our supply chain metrics allows for a consistent reporting platform for determining supply chain issues. We also needed a governance structure to monitor those metrics and provide actionable responses to the data in order to be proactive instead of reactive.

AMC has metrics to assess performance of each transformation process and of the supply chain itself. What we have measured since implementing S&OP in March 2013 shows that our endeavors

have had a positive impact on our supply chain. The number of spare parts put on back order is down from \$551 million to \$458 million, a difference of \$92.9 million or 17 percent. Inventory is down from \$22 billion to \$19.6 billion, an 11 percent reduction. In March 2013, we were over-forecasting by \$1.9 million. We have increased our forecast accuracy by 29 percent, which means a cost avoidance of \$1 billion—a significant accomplishment for item managers, given the extremely unpredictable industry in which we operate.

Figure 2 illustrates a dashboard system, with notional data, developed by AMC’s Logistics Support Activity for metrics analysis.

### CONCLUSION

AMC’s Supply Chain Transformation Team recently received the 2013



**KEEP IT MOVING**

Members of the Fort Hood, TX, Arrival/Departure Airfield Control Group (A/DACG) off-load an AH-64D Apache helicopter from a C-17 Globemaster on Fort Hood’s Robert Gray Army Airfield Nov. 14, 2013. The A/DACG coordinates, plans and executes the arrival, off-loading and departure of more than 10,000 tons of equipment and personnel every year. On a larger scale, AMC is seeking ways to improve the end-to-end management of spare parts, from supplier to Soldier, for the Army’s combat systems. (U.S. Army photo by SGT Ken Scar, 7th Mobile Public Affairs Detachment)



**PLANNING MAKES PERFECT**

Mark Harper, a transportation assistant with the Fort Hood, TX, A/DACG, discusses a load plan with Soldiers from the 42nd Combat Aviation Brigade as the unit prepared to deploy to Kuwait Nov. 21, 2013. AMC now has a challenge to shift from a reactive war environment to a proactive drawdown environment of managing and resolving supply chain issues before they become problems. (U.S. Army photo by Sgt. Ken Scar, 7th Mobile Public Affairs Detachment)

Department of Defense Award for Supply Chain Excellence.

AMC is embracing forward-looking planning and problem-solving. Through our current efforts and transformation initiatives to come, we can visualize long-range budget plans, demand forecasts and supply execution plans, and address any gaps before they become problematic. We are not sifting through measurements anymore; we are using meaningful metrics. The AMC workforce is shifting from transaction-based processes to analytics. We have learned the importance of measuring the “right” elements and will continue to ensure that the Army’s supply chain is efficient, relevant and always improving.

The success of the AMC transformation is the result of the dedication, determination and innovation of our people. The transformation team is building the necessary relationships with the workforce through supply chain workshops and leadership development programs, both starting in FY15. We are dedicated to improving morale, communication and supply chain management training so that we can retain and recruit the best in the business.

*For more information, contact the author at 256-450-8903.*

*MRS. JAMIE MILLER is the Supply Chain Transformation Team lead at AMC Headquarters, Redstone Arsenal, AL. She holds an M.S. in logistics from the Florida Institute of Technology and a B.S. in education from the University of Alabama. She is Level III certified in life-cycle logistics and has attended the Penn State Executive Program in supply chain management.*







## LEADING THE ARMY SECURITY ASSISTANCE ENTERPRISE

The Deputy Assistant Secretary of the Army for Defense Exports and Cooperation (DASA DE&C) leads the Army security assistance enterprise and links the world to Army innovation through foreign military sales, international armaments cooperation, and technology transfer and licensing to strengthen mutual defense capabilities.

DASA DE&C links the world to Army innovation by:

- Providing tools to allies and partners to safeguard our global community.
- Closing technology gaps through shared research and innovation.
- Fostering cohesion and unified effort, continuous improvement and service to our customers.
- Strengthening trust of our foreign, industry and institutional partners.



Deputy Assistant Secretary of the Army  
for Defense Exports and Cooperation  
(DASA DE&C)  
103 Army Pentagon  
Washington, DC 20330-0103  
703-614-3175

# SMART SUSTAINMENT

Tobyhanna workforce supports the current and future Army network, one idea at a time

*by Mr. Gary P. Martin, MG Daniel P. Hughes and COL Gerhard P.R. Schröter*

**W**hen you're at war, sustainment can be one of the last things on your mind. The Army acquisition community's top priority for the last 13 years was to get equipment out the door rapidly and into Soldiers' hands. If that required the occasional but necessary increased cost for repair or field support to ensure that troops had what they needed when they needed it, that was something to sort out later.

Later has arrived—and with it, an opportunity to be more strategic about how we execute sustainment for current and future systems. As the commercial defense industrial base adapts to fit a leaner Army, the organic industrial base will be called upon to provide more holistic life-cycle support, while staying ready to surge as contingencies demand. Fortunately for those of us in the Army communications-electronics community, Tobyhanna Army Depot (TYAD) has found one key to smarter and leaner sustainment: tap into the ingenuity of its workforce. By giving employees a voice and a stake in Tobyhanna's success, the depot fosters a culture of innovation that has led to a variety of process and product improvements and cost savings.

## **CULTURE OF INNOVATION**

Nestled in the Pocono Mountains of northeastern Pennsylvania, TYAD is the Army's center of excellence for the logistics support of communications and electronics equipment, including satellite terminals, radios, radars, night vision devices, airborne surveillance equipment and electronic warfare systems. Its capabilities range from the traditional depot work of maintenance and storage to original efforts in product design, fabrication, integration and field support. Rather than receiving congressional appropriations, Tobyhanna operates out of the Army Working Capital Fund, which aims to break even by returning any monetary gains to customers through lower rates, while collecting any losses from customers through higher rates. That transparency means that TYAD and other Army depots must act like the private sector, keeping overhead and rates low to satisfy their customers: the Army and other DOD program offices.

Unlike in the private sector, the situation is not quite "perform or perish," because of the "50/50 rule" that requires military programs to use the federal employees of the organic industrial base rather than private contractors for at least half of their maintenance and repair functions. But that doesn't mean

Tobyhanna leaders are content with just working the margins and taking their due. Indeed, Tobyhanna has busted two stereotypes about the public sector. First, by making efficiency part of its core sustainment mission, TYAD has ingrained continuous performance improvement in every aspect of the depot. Second, by cultivating a workforce and culture that are far from what people often think of as “typical government,” it has built an award-winning team that’s just as motivated as the customer to find the smartest way to do the job.

The efficiencies are well-documented. TYAD received national attention in 2012, winning the prestigious Shingo Silver Medallion that recognizes sustained dedication to “lean” processes and organizational self-assessment, after cutting in half the number of days to receive, process and shelve communications security (COMSEC) equipment. But the workforce side of the equation is where Tobyhanna truly stands apart from the stereotype. “Team Tobyhanna” consists of a combination of general-schedule, wage-grade and contract employees—all of whom are cross-trained on numerous systems and specialties so they do not become “siloes” in a particular area of expertise. Employees learn more skills and are motivated to tackle new challenges, and the depot can move workers to different systems as needed—for example, a technician who typically works with radar equipment could just as easily repair an urgent order of radios.

Through a program known as “Toby Tech,” the depot spends approximately \$8 million annually to train its workforce through partnerships with more than a dozen universities. Hands-on opportunities abound; more than 3,000 employees have volunteered for overseas deployments to support Operations Iraqi



#### **TOBY TECH**

Sarah Gomez, an electrical worker, assembles power distribution box switches using an invention that clarifies the sequence in which wires are used and prevents them from getting tangled during the assembly process. TYAD’s Toby Tech program trains its workforce through partnerships with more than a dozen universities. (Photo by Steve Grzezdinski, TYAD)



#### **LISTENING TO THE WORKFORCE**

John LaCapra, electronics mechanic helper, removes thousands of thumbscrews every month using a new device he designed that prevents injury and improves efficiency. By giving its workforce a voice and stake in its operations, TYAD promotes a culture of innovation. (Photo by Steve Grzezdinski, TYAD)



**PRIZE-WINNING EMPLOYEES**

TYAD's Communications Security Division improved the time it takes to receive, process and shelve equipment, cutting it by almost half. Division personnel used Lean techniques and brainstorming to improve processes, earning a Shingo Silver Medallion. (Photo courtesy of PEO C3T)



**PROCESS MADE SIMPLE**

Peter Anker, electronics worker, found a way to perform software upgrades on thousands of KG-175D encryption devices by simplifying a cumbersome process. As a result, employees were also able maximize work space. (Photo by Steve Grzedzinski, TYAD)

Freedom and Enduring Freedom, where they staffed forward-repair areas so that deployed troops could receive timely and affordable on-site maintenance for their communications equipment.

In addition to workforce development, the Tobyhanna culture fosters comprehensive and efficient sustainment by encouraging innovation from the bottom up. Employees at all levels receive public recognition when they suggest changes that are implemented both to improve their own work areas and to boost overall productivity. Some of the best ideas bubble up from the floor after new workers have spent just a few weeks on the job.

One employee suggested that buying a box-making machine would streamline the use of space for packaging COMSEC devices for shipping and storage. He earned a bonus and saved the depot up to \$75,000 a year. A former Marine Corps radio operator suggested changing the connection switch used to perform software upgrades on encryption devices so more could be modernized at the same time. His idea cost the depot nothing to implement, but reduced costs by 50 percent—savings that were returned to the operational unit that sent the devices and then reaped by subsequent customers. Just this summer, an electronics mechanic helper found a way to save time and the toll on employees' wrists and hands from manually removing and installing thousands of thumbscrews a month. He devised a socket adapter that attaches to a power screwdriver, making quick work of the 44 turns it takes to unscrew each of four thumbscrews found on a radio set's mounting base.

**DIRECT IMPACT**

This culture of innovation at TYAD has directly affected how we support and sustain Army network programs. When the



#### PROPOSED COST SAVINGS

Tobyhanna Army Depot employees begin to dismantle an aging AN/FSC-78 Satellite Communications Terminal Antenna Systems at Fort Detrick, MD, in 2013, putting in motion a value engineering proposal that will result in a \$30 million cost avoidance. (U.S. Army photo)

Army introduced the Nett Warrior system to extend digital communications to the dismantled Soldier as part of Capability Set 13, Tobyhanna engineers fulfilled the requirement for a cable to connect a commercial smartphone to a tactical radio—and went several steps further to deliver a full-service capability package.

Thinking from the perspective of the Soldier who would open the box, employees began to load and configure each phone and radio with the required mission data before shipping the systems to unit locations for training. They packaged the phone and radio in a single box complete with ancillary devices and charged batteries, then labeled each box with the role of the Soldier receiving it, so that Soldiers would open the box to find a customized, simple to use, fully operational kit. Loading cryptographic data is the only remaining task to be done on-site by

signal personnel. The idea, driven from the floor in response to user feedback, has significantly improved training procedures for units receiving capability sets.

Tobyhanna's efforts to cross-train employees are also paying off in the area of field support. As the Army right-sizes contractor field support for tactical communications systems, TYAD increasingly will provide total-package fielding support to help fill the gap. With the recent closure of the Product Management Office for Command Post Systems and Integration (CPS&I), a group of TYAD government employees who had executed new equipment training and new equipment fielding (NET/NEF) for CPS&I is now serving as a "surge team" to fulfill NET/NEF needs for other programs, so they don't have to continually pay for outside, system-specific field support representatives.

One of the most productive breeding grounds for sustainment efficiencies and employee ingenuity at Tobyhanna is the COMSEC division, a "depot within a depot." All supply and maintenance functions are in a single, secure facility. That provides a controlled environment to experiment with cradle-to-grave process improvements, from addressing misdirected shipments to packaging new items to upgrading or demilitarizing older devices.

Over the past three years, the COMSEC workforce has led the demilitarization effort to remove thousands of obsolete items from the shelves, saving millions of dollars while freeing storage space for modern equipment and standardizing the Army's COMSEC footprint. These efficiencies simplify network operations for Soldiers and enable better life-cycle management across the COMSEC portfolio.

**AS THE ARMY RIGHT-SIZES  
CONTRACTOR FIELD SUPPORT FOR  
TACTICAL COMMUNICATIONS SYSTEMS,  
TYAD INCREASINGLY WILL PROVIDE  
TOTAL-PACKAGE FIELDING SUPPORT  
TO HELP FILL THE GAP.**

**LEANING FORWARD**

For tactical communications acquisition programs, the next several years pose a combination of challenges in which we will look to the organic industrial base for help. The Army will continue to field integrated capability sets using new equipment; “clean up” the battlefield by converging and simplifying existing systems; and insert next-generation technologies to help create a robust, versatile network in support of Force 2025. Depending on program need, Tobyhanna may be called to take on a role previously filled by a prime contractor, serve as a subcontractor to a prime or participate in a hybrid arrangement that allows the vendor to retain control of certain information and processes while the depot does the rest.

For example, with the ongoing fielding of Warfighter Information Network – Tactical (WIN-T) Increment 2, the Army’s on-the-move tactical network backbone, to select brigade combat teams, the WIN-T Increment 1 program is transferring several functions formerly performed by its prime contractor to organic support. Working with the program office and vendor for the workforce to obtain the necessary data and training, Tobyhanna has begun to overhaul WIN-T Satellite Transportable Terminals. About 1,800 terminals are expected

to flow through the depot to be returned to like-new condition, establishing a pool of systems so units can swap their old terminals with no downtime.

Perhaps the biggest future sustainment challenge in Army communications-electronics equipment is tactical radios. For the new software-defined Rifleman and Manpack Radios, the Army is executing a Non-Developmental Item (NDI) strategy to create a competitive “radio marketplace” that incentivizes industry to offer superior products at lower costs. To mitigate the logistics challenges of working with multiple vendors, the Army is working to implement standards for ancillary items such as cables and installation kits, as well as to obtain the necessary technical data, to enable Tobyhanna to maintain and upgrade the NDI radios over the long term. We are applying sustainment lessons learned over the past several years, when the Army purchased several commercial off-the-shelf radio models in response to operational needs and TYAD adapted to support them, helping to shape this effort.

**CONCLUSION**

Even as budgets decline, the demand for tactical communications technologies is not diminishing—in fact, it will increase to enable a lean but still highly capable force. As these systems become more

integrated to form a holistic network, we must adopt a strategic approach that takes advantage of the value provided by the Army organic industrial base to make the most of our limited resources. It is time to bring sustainment back into the conversation, and doing that smartly goes beyond commitments at the leadership level. It takes an investment in the people closest to the work, and the desire to see through their eyes.

For more information, visit <http://www.tobyhanna.army.mil>.

*MR. GARY P. MARTIN is the U.S. Army Communications-Electronics Command deputy to the commanding general. He holds an M.S. in engineering management from the University of Pennsylvania and a B.S. in electrical engineering from Norwich University, and has attended the Harvard Business School, where he graduated from the Program for Management Development. He is a member of the Army Acquisition Corps (AAC).*

*MG DANIEL P. HUGHES is the program executive officer for command, control and communications – tactical (PEO C3T). He holds an MBA in business management from Oklahoma City University, an M.S. in national resource strategy from the Industrial College of the Armed Forces and a B.A. in political science from the University of Texas at Arlington. He is Level III certified in program management and a member of the AAC.*

*COL GERHARD P.R. SCHRÖTER is the commander of Tobyhanna Army Depot. He holds an M.A. in national security policy and strategic studies from the Naval War College, a B.A. in international studies and German from Virginia Tech and a certificate in International Security Policy.*



# 52 YEARS *and* **STILL SERVING**

## Tobyhanna deputy commander promotes culture of innovation



### A HALF-CENTURY AND COUNTING

Tobyhanna Army Depot Deputy Commander Frank Zardecki began working at the facility in 1966 as an electronics mechanic helper. He credits his long career at the facility to his natural curiosity and thirst for variety. (Photos by Steve Grzezdinski, Tobyhanna Army Depot)

**F**ranks Zardecki sits in the command suite, but he knows that the best ideas often come from the people getting their hands dirty. He was one of them.

After serving in the Air Force and attending Wilkes College in Wilkes-Barre, PA, Zardecki joined Tobyhanna Army Depot in 1966 as an electronics mechanic helper. Now he's deputy commander, with 52 years of government service under his belt. Zardecki is at the heart of what he calls the depot's "corporate philosophy": Everyone is accountable, everyone is invested and everyone should be heard.

"I always encourage employees to do their part in making the depot a better place to work and making us more effective overall," Zardecki said. "It's a very open culture of communication."

Zardecki sees a bit of himself in the depot's workers, many of whom are veterans. "It's a patriotic workforce, with a mission they can relate to," he said. "They are very committed to what they do."

Zardecki has been in a unique position to watch that mission evolve. When he signed up for the military, short-range, walkie-talkie style radios were the state of the art. As he climbed the ranks at Tobyhanna, the Army increasingly networked the battlefield, and today the depot supports a portfolio ranging from strategic satellite terminals to secure smartphones. It now accounts for 19,000 area jobs.

Along with changes in technology came a shift in identity. For the past decade, Tobyhanna has served not just as a single-location maintenance site, but also as an expeditionary capability that can surge and deploy support where needed.

"The number of forward-deployed personnel and the sophistication of their work have been among the biggest transformations in the organic industrial base," Zardecki said.

Having witnessed several periods of rising and falling military spending, Zardecki has perspective on how the depot can weather any fiscal climate. He is a numbers fiend who constantly analyzes the



**MAN IN THE MIDDLE**

Variety is the hallmark of Zardecki’s career at Tobyhanna Army Depot, where one day might find him touring with senior military leadership and another working with technicians on the shop floor. He champions what he calls the depot’s “corporate philosophy”: Everyone is accountable, everyone is invested and everyone should be heard.



**WIRED FOR CHANGE**

Integrated Systems Electronic Mechanics Adam Wojcicki, left, and Chris Sicurella run systems tests on the AN/TSC-185 Satellite Transportable Terminal at Tobyhanna. Zardecki has seen considerable change during his tenure at Tobyhanna, which now supports a broad technical portfolio, has an expeditionary capability that could surge and deploy support where needed, and accounts for 19,000 area jobs.

depot workload, how it is distributed and how it can be completed more efficiently.

“It’s imperative that we maintain competitive rates so that our customers can afford to come here, especially in the time of declining budgets,” he said. “That’s something that Tobyhanna works on really hard, all the time: trying to keep our rates down. When program managers have a choice, we want them to choose Tobyhanna.”

He credits his longevity to a natural curiosity and thirst for variety—“one day I could be talking to a senator, the next I might be on the floor with a technician”—and dedicated training regimen. Zardecki has attended numerous courses in the field of management, including supervision, leadership, labor relations, maintenance management, the environment, automation and lean processes. He is a 1995 graduate of the Senior Executive Fellowship Program at Harvard University’s John F. Kennedy School of Government.

“You can never get enough training, especially now that technology is constantly changing,” he said. “The opportunities are out there for everyone, and we make a point to emphasize that.”

While Zardecki’s expertise and longevity could have led to a position at the Pentagon or any other Army installation, his commitment to Tobyhanna is unwavering—and he shows no signs of readying for retirement.

“I’ve had a few opportunities to move to other facilities, but I knew I could accomplish the most at Tobyhanna,” he said. “It’s been 52 years, and there’s still more to do.”

**—TOBYHANNA ARMY DEPOT AND  
PEO C3T PUBLIC AFFAIRS STAFFS**



# U.S. Army Materiel Systems Analysis Activity



# AMSAA

**Excellence in Analysis**



**AMSAA Mission:** Conduct analyses across the entire materiel life cycle to inform critical decisions for current and future warfighter needs while valuing the unique knowledge, experience and backgrounds of its people.

***Five Decades of Analysis Serving the Warfighter!***



U.S. Army Materiel Systems Analysis Activity  
392 Hopkins Road  
Aberdeen Proving Ground, MD 21005-5071  
[www.amsaa.army.mil](http://www.amsaa.army.mil) 410-278-6614



# SPOTLIGHT

## MR. JONATHAN HENSHEY

Active-duty perspective  
benefits acquisition career



### MR. JONATHAN HENSHEY

**COMMAND/ORGANIZATION:**

Program Executive Office for Aviation,  
HQ staff

**POSITION AND OFFICIAL TITLE:**

Chief of system safety

**YEARS OF SERVICE:**

5 years in the workforce, 23.5 years  
of military service

**AWARDS:**

Commander's Award for Civilian Ser-  
vice, Achievement Medal for Civilian  
Service

**EDUCATION:**

M.S. in aeronautical science (dual  
specialization in management and  
operations); B.S. in professional  
aeronautics (minor in aviation safety),  
Embry-Riddle Aeronautical University

Having spent nearly 24 years on active duty, Jonathan Henshey thought he had a pretty good understanding of the acquisition process. But when this CW4 retired from the Army and joined the acquisition workforce in 2008, he learned just how intricate the process can be.

Henshey started his active-duty career as an infantryman but served the bulk of his time as an Army aviator. He flew UH-1 Iroquois and OH-58 Kiowa helicopters as well as the U-21, the C-12, the RC-12 and the VC-35 fixed-wing aircraft in posts as diverse as North Carolina, Alaska, Iraq and Bosnia.

He started his civilian career in the Program Executive Office (PEO) for Aviation's Fixed Wing Project Office as the system safety manager. "I was only the second person to manage that office," he said. "Given how old the Army is and how long the Acquisition Corps has been around, I was surprised that the office was as new as it was."

Henshey is now at PEO Aviation HQ, where he serves as chief of system safety. "Most people are surprised to hear that there is such a thing as system safety. They usually only think of operational safety and how we ensure that people do things safely," he said. "System safety addresses the hazards that the system can potentially present to the operator, even if he or she does everything properly. A system is not as effective as it could be if it can injure or kill its operator in spite of their flawless execution of the mission."

He recently passed the five-year mark at PEO Aviation. "When I was on the operations side, I didn't fully understand all the moving parts of acquisition and what it took to go from concept to fielding, sustainment and eventually retirement [of a system]," he said. "I now understand much better how acquisition works—the process is complex and dynamic, with a lot of moving pieces—and I'd like to see it become a little quicker and more responsive."



#### AIRCRAFT INSPECTION

Jonathan Henshey, left, with Britt Thomas of Dynamic Aviation, conduct a system safety inspection of a Beechcraft King Air 200 undergoing mission equipment integration. (Photo by Don Williams, Avion Solutions, for Fixed Wing Project Office)

#### What do you do, and why is it important to the Army or the warfighter?

I currently oversee all aspects of system safety for Army aircraft. By implementing DOD and Army regulatory guidance and PEO Aviation policy, I am able to ensure that the principles of system safety are applied throughout the entire life cycle of the aircraft. This is important to the Army and the warfighter because a system that presents hazards to the operator results in decreased combat effectiveness and negatively impacts mission success.

#### During your career with the Army AL&T Workforce, what changes have you noticed—in processes, training, equipment, etc.—that have impressed you the most?

I am most impressed by the opportunity for formalized training through the Defense Acquisition University. It has proven to be a very effective training experience that produces a better acquisition workforce.

#### Acquisition has changed profoundly in many ways in the past 25 years. How do you see it changing in the future, or how would you like to see it change?

I would like to see Army Acquisition become more streamlined and efficient in the future. It currently seems to be a very slow and arduous process that has a difficult time fielding current technology in a timely manner. I remember the concept for the V-22 Osprey being discussed when I was in high school, and we saw that fielded just recently.

Often, technology is already outdated by the time it is fielded. And trying to combat that results in a program's most detrimental characteristic, mission capabilities creep. There is a desire by the material developer to try to include the latest technology in a program, but that results in very expensive changes with the contractor and, often, interference with the original design.

#### What's the greatest satisfaction you have in being a part of the AL&T Workforce?

My greatest satisfaction comes from having the ability to influence the safety of the aircraft that my fellow aviators are currently flying, along with continuing to serve my country in a meaningful way.

—MS. SUSAN L. FOLLETT

# FUTURE [WORK]FORCE

Developing the Army's next generation of scientists and engineers

*by Dr. Grace M. Bochenek and Ms. Jessica A. Smith*

**T**o maintain dominance, the Army must posture itself to proactively innovate, to identify promising technologies, to develop solutions and to deliver capabilities. A key part of delivering future capabilities is the creation of a flexible workforce of engineers and scientists with the right skills to support emerging areas of research and development. To achieve this, the Army must answer some not-so-straightforward questions:

Which technical competencies will be required within the workforce in the next 25 years? The next 50? What will maintain the knowledge base and technology overmatch built over the last 50 years? How should systems engineering and other workforce skills that require a breadth of knowledge and experience be developed?

Ask someone what it takes to become an engineer or scientist, and you will likely hear that you should get good grades in school and focus on math and science. But what if you ask instead what it takes to become the program manager for one of the world's most advanced missile systems? Or how to become an industry leader in the treatment of battlefield trauma? Odds are you will get a variety of different answers, if you get a clear answer at all.

*“The challenge for the civilian workforce is to keep pace with the realities facing an Army winding down after more than a decade of conflict. We will meet that challenge by being flexible and adaptive with the right person possessing the right skills, at the right place at the right time—competent, motivated and educated.”*

*—John McHugh,  
Secretary of the Army*



FIGURE 1



**DEVELOPING ENGINEERS AND SCIENTISTS**

The CP-16 proponency office is collaborating with subject-matter experts to develop competencies for each of its 61 occupational series. (SOURCE: Jessica A. Smith, CP-16 Proponency Office)

**A NEW MODEL FOR DEVELOPMENT**

To guide its workforce, the Army has created a new development model that focuses on establishing and managing workforce competencies (knowledge, skills, abilities, etc.) based on the Army’s predicted technical needs rather than static step-by-step career progressions. This method will allow civilian workforce

personnel to hone their existing skills and to develop new competencies as the needs of the Army change.

As part of first gaining an understanding of its extremely diverse workforce (everything from botanists to aerospace engineers to surgeons), the Army has aligned every member of the civilian workforce to one of 31 unique career programs (CPs). These

CPs group employees by job series (for example, 1301– physicists) based on commonality of job and similar qualification characteristics. (See Figure 1.) CPs work to support the entire life cycle of their workforce, from recruitment to retention to future forecasting and planning.

Within each CP are a functional chief (FC), a functional chief representative



**NEUTRALIZING THE THREAT**

Jason Hamilton, electronics mechanic at Tobyhanna Army Depot, PA, reassembles a Duke primary unit. Duke is a counter-improvised explosive device (IED) system that jams IED frequencies. The Army has created a new development model that focuses on establishing and managing workforce competencies based on predicted technical needs rather than static step-by-step career progressions. (Photo by Steve Grzedzinski)



**MAKING CHOICES**

Kelly Pippin, Army Continuing Education Services administrative manager at Fort Benning, GA, guides SSG Jacob Rutledge, of 1st Battalion, 19th Infantry Regiment, through setting up a GoArmyEd account. The system enables personnel to find and schedule training for their career field. (Photo by Brittany Smith)

(FCR) and a proponency office. FCs are responsible for identifying workforce issues, working with commanders to develop annual strategic plans that account for the changing needs of the Army, and ensuring readiness of their occupational field across the enterprise. FCRs are appointed senior (usually civilian) officials who help to develop career program instructions and procedures, engage commands and supervisors to identify the workforce capabilities needed to meet current and future missions, review and evaluate annual competitive professional development and functional training, and handle a variety of other senior-level career program administrative functions. Proponency offices, established in FY14, assist FCRs with career management responsibilities, including dissemination of information to all applicable workforce members regarding professional development and training opportunities, administration of the centrally funded Army Civilian Training, Education and Development System intern and competitive professional development programs, and advising career program managers within the activities of regulatory, administrative and procedural requirements.

Career Program – 16 (CP-16) manages the Army’s non-construction-related engineers and scientists. The proponency office for CP-16 is currently working with subject-matter experts to develop competencies for each of its 61 occupational series using the Competency Management System (CMS). CMS organizes the developed competencies into tiers based on the population to which the competency applies. As Figure 2 indicates, Tier 1 competencies (series core) will apply to all personnel within a job series. Tier 2 competencies (specialty core) will apply to all personnel within a specialty area of a series, and Tier 3 competencies



FIGURE 2

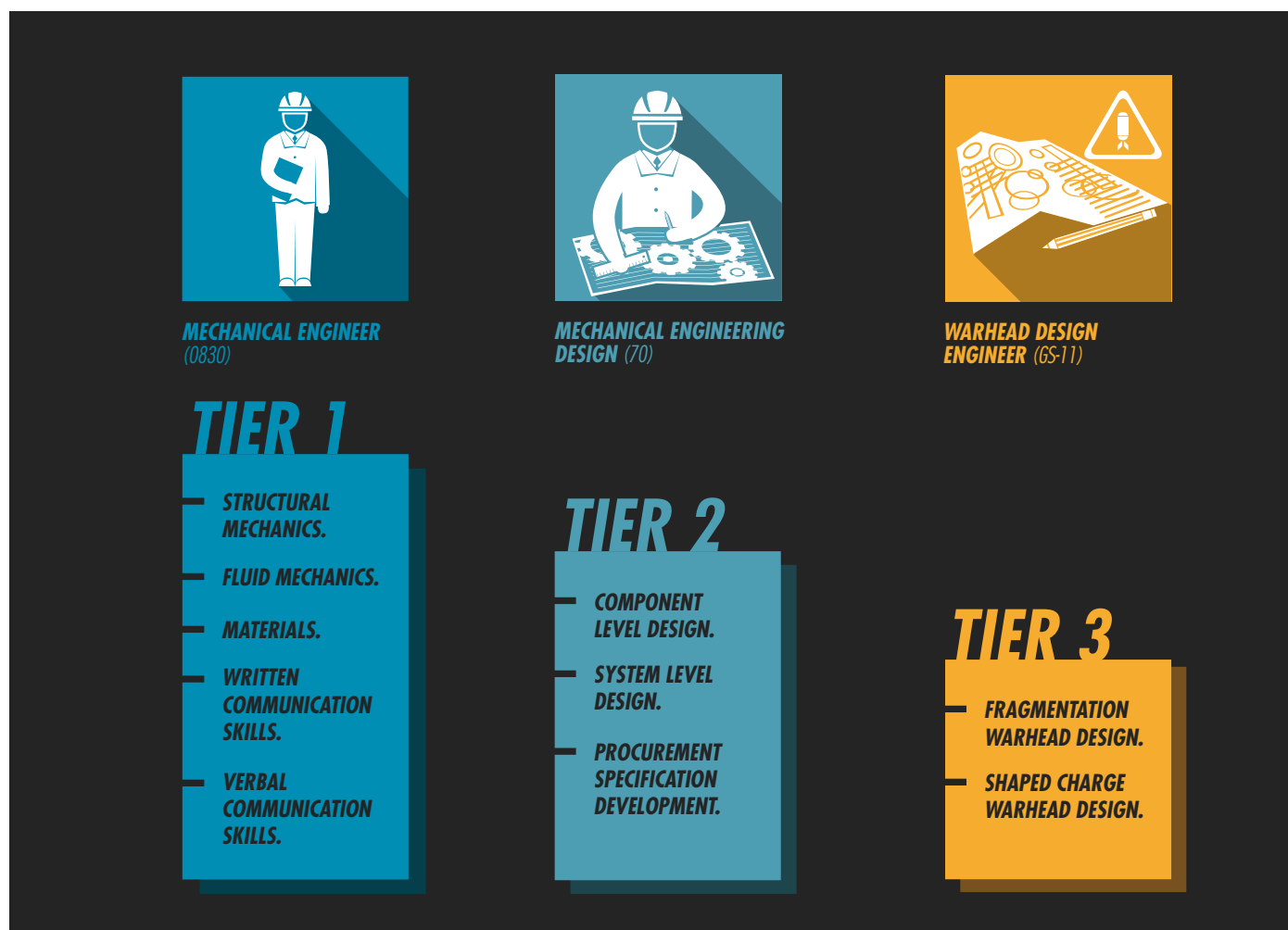

**MEASURING PROGRESSION**

CMS organizes the developed competencies into three tiers based on the population to which the competency applies. (SOURCE: Jessica A. Smith, CP-16 Proponency Office)

(position- and grade-specific) will apply to a particular position and grade level within a series and specialty.

Under current timelines, roughly 80 percent of the series within CP-16 was scheduled to have initial competencies assigned by the end of September 2014. Once the competencies are established, CP-16 personnel and their supervisors will be able to view competencies for a position, assess their performance against

those competencies, and determine which development opportunities will best posture them to take the next step in their career.

By the end of FY14, more than 80 percent of the series within CP-16 are expected to have initial competencies assigned. Each series will undergo a refresh at least every two years, whereby competencies will be updated to reflect the most current Army science and technology priorities. This

method will help provide the workforce with a clear picture of what capabilities will be most valuable to the Army as they continue their career development.

**ACT, GOARMYED PLAY A ROLE**

Two of the tools that the Army is using to support this new competency-based model are Army Career Tracker (ACT) (<https://actnow.army.mil/>) and GoArmyEd (<https://www.goarmyed.com/>). ACT allows personnel to perform

# GoArmyEd



## CAREER TRACKER

ACT allows users to search and select education and training opportunities, monitor career development and get personalized advice from their leaders about which opportunities may be the most helpful. It's also the place where users establish their IDPs. GoArmyEd provides students the means for requesting and scheduling training once their IDP is in place. (Image courtesy of Jessica A. Smith)

a variety of developmental functions, including determining their assigned career program; viewing their progress on required training such as Civilian Education System courses and Defense Acquisition Workforce Improvement Act certifications; exploring career maps and competencies for their current position and grade and for desired positions and grades; and establishing an individual development plan (IDP) to map out training for advancement. After establishing an IDP within ACT, users can access GoArmyEd to request training, receive approval for courses and then register for training.

So what does this new approach mean for the engineers and scientists? The acquisition workforce? The supervisor? The program manager? It means that the Army is actively working to create a more forward-thinking workforce by providing visibility into desired skills and future workforce needs. It also means that there are a variety of opportunities, tools and funding to help develop workforce personnel and to provide the Army with a highly skilled workforce. To get started, members of the acquisition workforce should establish their accounts within ACT and GoArmyEd and begin building their IDPs.

## CONCLUSION

For the future, it is paramount that the Army focus not only on its investments in technologies, but also in its technical workforce. As Chief of Staff of the Army GEN Raymond T. Odierno has said, “We need our scientists; we need our engineers; we

need our Ph.D.s to help us come up with new ideas and technologies for us to take care of our young men and women in uniform.” The Army’s new competency-based workforce development model and workforce-focused proponent offices will provide the ability to recruit, develop and retain personnel with the right skill sets. Today’s interns will deliver tomorrow’s breakthroughs—on and off the battlefield.

*For more information on career program management for engineers and scientists, contact the CP-16 Proponent Office at 256-450-8781 or [usarmy.redstone.usamc.mbx.army-cp16-pmo@mail.mil](mailto:usarmy.redstone.usamc.mbx.army-cp16-pmo@mail.mil).*

---

*DR. GRACE M. BOCHENEK is the first chief technology officer for the U.S. Army Materiel Command and functional chief representative for CP-16. She has a Ph.D. in industrial systems engineering from the University of Central Florida, an M.S. in engineering from the University of Michigan and a B.S. in electrical engineering from Wayne State University.*

*MS. JESSICA A. SMITH is a career management specialist with the CP-16 Proponent Office. She has a B.S. in mechanical engineering from the Georgia Institute of Technology and is Level III certified in systems planning, research, development and engineering.*





## The Army Application Migration Business Office

Contacting the Army Application Migration Business Office is the first step to building an effective migration plan with the Defense Information Systems Agency (DISA).

The Army Application Migration Business Office will help you identify a viable solution or vendor to provide modernization and virtualization services.

The Army Application Migration Process is part of the Army Data Center Consolidation Plan to move enterprise applications to DOD-approved hosting facilities by the end of fiscal year 2018. The Army Application Migration Business Office:

- Serves as the single point of contact between system/application owners and DISA.
- Provides subject-matter expertise to assist in the on-boarding process.
- Performs engineering analysis to assist in right-sizing applications.

**Email:**

USArmy.Belvoir.PEO-EIS.mbx.Army-App-Migration-Office@mail.mil

**Call:**

1-866-335-ARMY or 1-866-335-2769 and select option 4.

**Submit:**

a ticket to <https://esd-crm.csd.disa.mil/app/ask>



# ELITE TRAINING

New game-based simulation expands  
to teach new leaders ‘soft skills’

*by Mr. Timothy G. Wansbury, Dr. Randall W. Hill Jr. and Ms. Orli Belman*

Effective leaders counsel subordinates for a variety of reasons, from providing feedback for exceptional duty performance to giving guidance to those dealing with personal or work-related problems. Army Field Manual (FM) 6-22 (Army Leadership: Competent, Confident, and Agile) aptly states that counseling is one of the most important leadership development responsibilities for Army leaders.

Traditional training for counseling has relied on a mixture of classroom lectures and discussion, role-playing exercises and hands-on practice filling out counseling forms. However, as early as this fall, the Army will begin changing how it trains junior military leaders to counsel subordinates.

Soldiers will soon be able to learn basic principles of counseling and practice their skills using a laptop-based application called the Emergent Leader Immersive Training Environment (ELITE) Lite. This new training system uses low-cost, game-based “interpersonal communications simulation” in which students conduct interactive counseling sessions with virtual characters in scenarios specifically designed to represent sessions that are challenging for young, inexperienced leaders. These include issues of on-the-job personnel conflicts, financial and family stresses, substance abuse, and other personal difficulties and performance concerns.

The ELITE platform represents a new generation of training simulation—one that employs sound instructional design principles along with game technologies to help junior leaders develop “soft” leadership skills like interpersonal communication and counseling. The system employs “virtual human” role-players instead of live actors in engaging practice exercises. It uses artificial intelligence technologies to assess student performance and provides embedded coaching and tutoring as students work through instruction and practice exercises. Much of the research and development (R&D) that produced the ELITE experiences takes place at the University of Southern California Institute for Creative Technologies (USC ICT), a DOD-approved, Army-sponsored, university-affiliated research center.

## THE ELITE EXPERIENCE

ICT’s interest in developing the original ELITE system was inspired by the Army Learning Concept (ALC) 2015, which describes the Army’s goal to transform institutional training away from traditional classroom lessons in favor of new dynamic learning environments. Although not focused on any one technology, ALC 2015 envisions using a variety of new virtual environments and game-based technologies to meet the learning needs of future generations of Soldiers.



#### VIRTUAL SARGE

Virtual SSG Jacob Garza comes to life via laptop in ELITE Lite, an interpersonal skills trainer that will soon be available Armywide as an interpersonal-communication simulation for leader development training. Garza is one in a long line of virtual humans developed at the USC ICT. (Image courtesy of USC ICT)

ELITE provides instruction on key leadership concepts through engaging, interactive classroom instruction and provides the opportunity for students to apply their new knowledge and skills in practice exercises that include performance assessment and feedback in an after-action review (AAR).

ICT has produced two ELITE prototype applications under its Army mission-funded R&D program. The first prototype is a mixed-reality-based solution that was designed for an instructor-facilitated, classroom environment. Mixed-reality environments combine real-world and virtual elements.

In the mixed-reality version of ELITE, a student selected from a group of up to 50 students sits in a room close to the main

classroom, called the Digital Immersive Virtual Environment (DIVE). The DIVE looks like a typical work area (office, motor pool, etc.) for a junior leader. The student, in the role of the leader, sits at a desk in this set-designed office space and interacts with a life-sized virtual human subordinate, who appears on a screen in a digital version of the same office.

The student leader “speaks” to the virtual character through a microphone, selecting what he or she says from a list of carefully constructed statements. The virtual character has the ability to understand the spoken word and responds to the student in a lifelike, natural manner. The character uses realistic body language, gestures and facial expressions to help make the engagement as realistic as possible. While the student engages with the

virtual human in the DIVE, the remaining members of the class can watch the engagement on video screens and participate themselves in the training by using “clickers” to select what they feel are the best leader choices from the same list of statements provided to the student in the DIVE. An instructor-control station captures performance data, including the answers selected by the leader and the classmates following along, to support an instructor-facilitated AAR.

ICT researchers installed the Army’s first mixed-reality ELITE prototype at the U.S. Army Maneuver Center of Excellence (MCoE), Fort Benning, GA, in October 2011. Together with MCoE personnel, the researchers conducted a number of training sessions for officers and senior NCOs. SMA Raymond F.

Chandler III, having observed an early demonstration of this system in spring 2012, told the Benning Report television news program that counseling was an area of challenge for the Army. “Any tool we have that will make us better at developing our subordinates is in turn going to help us develop a better Army. The ELITE trainer is one of those tools,” Chandler said.

### ELITE LITE

The second and newest ELITE prototype is called ELITE Lite, a self-paced, laptop-based version of the original mixed-reality ELITE. It is designed to be used either as a stand-alone, self-paced trainer or as part of an instructor-facilitated classroom exercise.

ELITE Lite offers many of the features of the much larger, mixed-reality version of ELITE. Both systems provide up-front instruction on the basic doctrinal concepts of counseling as outlined in Army FM 6-22, Appendix B (Counseling). Each system includes practice exercises using virtual human characters and artificial intelligence to assess performance and provide coaching, tutoring and feedback during training and in an AAR. Each system has five performance counseling practice scenarios that reflect situations and leadership challenges that many young leaders are likely to experience. The two most recently completed counseling scenarios were developed in partnership with the Army Sexual Harassment/Assault Response and Prevention Program Office.

While the ELITE mixed-reality version of the training relies on an instructor-facilitated AAR, ELITE Lite concludes with a self-guided AAR. In each case, students receive an overall score for their performance in the practice exercises, and they learn which tasks they



### HOW'D I DO?

This screen shot from the ELITE Lite informal counseling trainer, a self-paced, laptop-based tool, depicts an after-action review, which provides students an assessment of their performance and which skills they need to improve. (Image courtesy of USC ICT)

did well and which areas need improvement. Future versions of ELITE Lite will provide a network capability that will allow instructors to monitor performance during training and capture it in an instructor station, a capability very similar to what is currently available in the mixed-reality version of the system.

There are however, three big differences between the two versions of the system. ELITE Lite is a laptop-based, virtual human application and therefore has no mixed-reality, DIVE experience. Second, students use a mouse with ELITE Lite to select from a list of text options in order to communicate with the virtual character; they do not use a microphone to speak directly to the character, as with the mixed-reality version. Third, because it is a laptop-based application, the cost to develop and distribute ELITE Lite is a fraction of what it would cost to deploy the mixed-reality solution across the Army.

### VIRTUAL HUMANS

Virtual humans are computer-generated characters that use language, have appropriate gestures, show emotion, and react to verbal and nonverbal stimuli. Over the past 15 years, advances in computer graphics and artificial intelligence have allowed researchers to model individual and group behaviors realistically. This has led to significantly enhanced capabilities of simulation, comparable to the capabilities of flight simulators, to support training in the human dimension.

Virtual humans in ELITE Lite provide a cost-effective alternative to the traditional use of human role-players in counseling training. The virtual humans in ELITE Lite can be available 24/7, and there is little or no cost to use or maintain the ELITE Lite system after its fielding. The use of virtual humans in ELITE Lite provides an opportunity to introduce diversity—of gender, race, age and cultural background—among the various

role-players in the practice exercises, whereas achieving the same degree of diversity with live actors would be difficult while providing training across the Army. Virtual humans also provide a much-needed, standard and consistent training experience with which to assess interactions across the entire Army.

### AN ARMYWIDE TOOL

ICT completed the first version of ELITE Lite in June and is working with the U.S. Army Research Laboratory (ARL) to transition the application to the Army's Program Executive Office for Simulation, Training and Instrumentation (PEO STRI) and the Army Games for Training Program. The U.S. Army Combined Arms Center recently finalized the accreditation of ELITE Lite, and PEO STRI has obtained an approved certificate of networkiness, thereby permitting users to install the ELITE Lite software on Army networked computers. The Games for Training Program will soon begin to distribute the ELITE Lite software Armywide via the Army Mil-Gaming Portal.

The Department of Behavioral Sciences and Leadership at the United States Military Academy (USMA) at West Point has amended the curriculum for PL300: Military Leadership to include a block of instruction on counseling. This academic course for all third-year cadets is an integral part of each cadet's leader development training.

The department has chosen to use ELITE Lite to aid in cadet learning. Starting with the 2014-15 academic year, approximately 600 cadets per semester (1,200 per year) will use ELITE Lite as a supplement to the classroom instruction. The U.S. Army Sergeants Major Academy is also investigating the use of ELITE Lite in the Warrior Leader Course.



### COUNSELING CENTER

ELITE Lite teaches interpersonal skills to Army junior leaders by presenting real-world instructional scenarios in an engaging, self-reinforcing manner. The purpose of the training experience is to give junior leaders an opportunity to learn, practice and assess interpersonal communication skills for use in basic counseling. (Image courtesy of USC ICT)

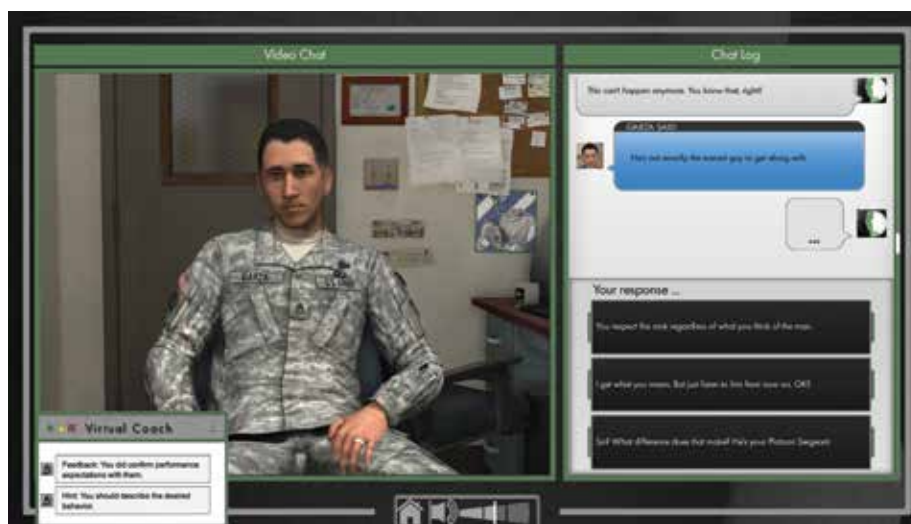

### A LEADER IN HIS FIELD

This screen shot from the ELITE Lite informal counseling trainer depicts an interaction with virtual SSG Jacob Garza. An artificial intelligence-based virtual coach offers guidance for students as they navigate the challenges of conducting a performance review in this game-based leader development trainer. (Image courtesy of USC ICT)



**MIXED-REALITY MAN**

Virtual SSG Jacob Garza is part of the ICT's mixed-reality ELITE prototype installed at MCoE in October 2011. ELITE Lite, by comparison, is a laptop-based application whereby students use a mouse to select from a list of text options to communicate with the virtual character. By providing a portable version of the full mixed-reality prototype, ELITE Lite costs a lot less to develop and can now be distributed across the Army via the MilGaming Portal. (Image courtesy of USC ICT)

The Army recently approved a new set of requirements for a follow-on, enhanced counseling skills trainer. The new solution, called ELITE Pro, will require an expansion of the ELITE Lite platform to include a new networked capability with enhanced instructor assessment and feedback. ELITE Pro will also contain a new set of scenario authoring tools, which will support the rapid development of new scenarios and training content.

**CONCLUSION**

ICT's long-term vision is to expand the capabilities of the ELITE platform to allow for its use in satisfying additional leadership development training requirements in the future. The institute is also exploring new opportunities for using virtual humans to improve training, education and health care.

In addition to delivering a new method for training young Army leaders, the ELITE project demonstrates how key stakeholders representing Army combat developers, materiel developers, researchers within the R&D community (both government and academia), and content subject-matter experts can work together to design, develop, transition and field an effective training solution for the Army.

For more information, go to [www.ict.usc.edu](http://www.ict.usc.edu).

---

MR. TIMOTHY G. WANSBURY is a technology transition officer with the Simulation and Training Technology Center of ARL's Human Research and Engineering Directorate. A retired Army colonel with 25 years of service as a finance corps officer and comptroller, he holds an M.S.

*in business administration from the Army Comptrollership Course at Syracuse University and a B.S. from the University of Vermont, and is a graduate of the U.S. Army War College.*

DR. RANDALL W. HILL JR. is executive director of USC ICT. He holds a Ph.D. and M.S. in computer science from USC, and a B.S. from USMA. He served for six years as a commissioned officer in the Army, with assignments in field artillery and military intelligence. He is a member of the Association for the Advancement of Artificial Intelligence and serves on the Board on Army Science and Technology of the National Academies.

MS. ORLI BELMAN is the public relations and projects manager at ICT. She has an M.S. in journalism from Columbia University and a B.A. in East Asian studies from the University of California, Los Angeles.



U.S. ARMY

PEO  
IEW&S

# Spectrum Dominance at the Tactical Edge

-  ELECTRONIC ATTACK
-  CYBER ATTACK
-  SIGNALS INTELLIGENCE
-  ELECTROMAGNETIC SPECTRUM OPERATIONS

PM Electronic Warfare is a world-class organization that delivers an integrated capabilities portfolio to the warfighter to dominate the electromagnetic spectrum and cyberspace. We develop, field and sustain agile, affordable and holistic materiel solutions by integrating electronic warfare, cyber, spectrum and signals intelligence capabilities to provide the warfighter freedom of maneuver on the battlefield.



ATTACK • PROTECT • SUPPORT



## HEAVY USE

Soldiers of 4th Battalion, 25th Field Artillery Regiment, 3rd Brigade Combat Team, 10th Mountain Division (3-10 MTN) calibrate their M119 howitzer during a live-fire exercise Jan. 15 at Forward Operating Base Lighting, Afghanistan. The howitzer has seen extensive use in the rugged territory of Afghanistan, which over time has caused damage to the lower carriage and baseplate of the weapon. (Photo by SGT Javier Amador, 3-10 MTN Public Affairs)





# ADAPTING ARTILLERY

Design change strengthens battle-worn M119A3 howitzer at less cost than new system

*by Mr. Joseph Lipinski and MAJ Wade Perdue*

Over a decade has passed since the beginning of Operation Enduring Freedom (OEF), and the Army has asked more from its artillerymen than at any time in history. No matter what the mission, from multiple deployments to conducting nonstandard missions in some of the most remote locations in the world, artillerymen have always been flexible and adaptable. But high-altitude mountain warfare has tested more than the limits of our Soldiers; it has tested the limits of the howitzers they fire, as witness the M119A3.

With its extended range, accuracy, reliability and mobility, the M119A3 howitzer has proven to be a vital fire support platform for infantry brigade combat team (IBCT) commanders. The howitzer has seen extensive use in the mountainous territory of Afghanistan, firing multiple-round, high-angle, high-charge missions daily in support of combat troops. Continuous firing of high charges at high angle caused component damage, such as holes and cracks, on the lower carriage and baseplate of the M119A3, eventually making these items unserviceable. “High angle” defines fire delivered at elevations greater than that of the maximum range for the gun and ammunition concerned. Range decreases as the angle of elevation increases.

High-angle fire is used for firing into or out of deep defilade, such as that found in heavily wooded, mountainous and urban areas. It is also used to fire over high-terrain features near friendly troops.





### SIGNS OF WEAR

Damage, such as cracks and holes, occurs during high-quadrant elevation, high-charge firings when the existing bump stops impact the firing platform. (Above photos courtesy of MAJ Wade Perdue, PM TAS)

To correct the damage problem, the Office of the Project Manager for Towed Artillery Systems (PM TAS) of the Program Executive Office for Ammunition, in collaboration with engineers at the U.S. Army Armament Research, Development and Engineering Center (ARDEC), developed a creative solution known as the Suspension Lock-Out System (SLOS), which PM TAS will begin fielding during the fourth quarter of FY15.

The SLOS will not only alleviate holes and cracks on the lower carriage and the firing platform, but will also provide increased howitzer stability when firing all quadrant elevations with top-zone propelling charges, essentially allowing M119A3 crew members to provide more accurate and responsive fires. Quadrant elevation is the angle between the level base of the trajectory and the axis of the bore when the howitzer is laid, or simply the elevation or depression of the howitzer gun barrel. The quadrant elevation of the M119A3 ranges from -100 mils minimum to +1,244 mils maximum.

### STRONGER DESIGN

The hardware for SLOS has three main components: struts and brackets, a fixed-recoil system and a titanium firing platform. The struts and brackets are lightweight, titanium, easily installable and field-deployable mechanisms that attach to the lower carriage of the howitzer. The SLOS kit removes the

problematic variable-recoil hardware and replaces it with a fixed-recoil system. With the fixed-recoil system, the maximum recoil the operator will experience during operations, including high-angle, high-charge fire missions, will be 25 inches. With the variable-recoil system, the maximum recoil at maximum elevation is 14.5 inches, and the maximum recoil at minimum elevation is 42 inches.

The fixed-recoil system translates into reduced firing loads on the carriage, thus increasing durability and reliability of the howitzer, and improves the rate of fire by significantly reducing unwanted displacement, or the unwanted movement of a howitzer caused by the shock of firing. Such movement requires the crew to realign the howitzer to the gun target line after each shot fired. Reducing displacement means more responsive fires and less wear and tear on the howitzer.

The titanium firing platform is an enhancement to the currently fielded aging steel firing platform. The legacy platform, made of aluminum and steel, is a multipiece assembly consisting of approximately 200 fasteners with significant welding. Though this design has served the Army well since it first saw service with the 7th Infantry Division in 1989, recent combat operations in OEF identified the need for a stronger, more durable platform.

**IN ADDITION TO REDUCING PERFORMANCE RISK THROUGH WELL-DEFINED REQUIREMENTS, THE TEAM IMPLEMENTED BOTH FIRST ARTICLE TESTING AND FIRST ARTICLE CONFIRMATORY TESTING IN THE INSPECTION-AND-ACCEPTANCE PORTION OF THE CONTRACT.**

The redesigned titanium firing platform will be cast as a one-piece molded system, thereby eliminating multiple parts and fasteners while still serving the same purpose as the original platform. Another added benefit of the titanium platform is a reduction in weight; it is 30 pounds lighter than the legacy platform. It also incorporates new carrying handle geometries to increase robustness and carrying comfort. The legacy platform's handle holes had sharp edges and often caused strain on the users' hands during emplacement and displacement. The new design recognizes human factors and ergonomics. The new handles have a much larger, smoother surface to help reduce strain.

Although the titanium platform costs slightly more than the legacy platforms—roughly 7 percent more per unit—a greatly reduced logistics footprint mitigates the constant repair and replacement of legacy platforms, resulting in a significant increase in mission readiness and availability.

#### **CONTRACTING TOOLS**

PM TAS awarded the SLOS and the titanium platform base contracts in

FY14 as five-year, indefinite delivery/indefinite quantity contracts with firm, fixed-price (FFP) delivery orders. Design West Technologies Inc. of Tustin, CA, is the prime contractor for the SLOS, and Alcoa Howmet of Hampton, VA, is the prime contractor for the titanium firing platform. The ability of the PM TAS/ARDEC team to identify and mitigate performance risk early on by clearly articulating the contract specifications and thoroughly defining requirements has significantly reduced the overall risk to both the government and the prime contractors. These initiatives in turn promoted effective competition, allowing the government to obtain the goal of best value during the source selection process.

An example of how the team reduced technical and performance risk that the prime contractor might have incurred with the FFP contract is through the product technical data package (TDP) and the statement of work (SOW). Before the release of the request for proposals, PM TAS and ARDEC engineers tailored a TDP and SOW for the SLOS and the titanium platform. The TDP and SOW communicated a clear and complete description of the requirements



#### **SIMPLER, LIGHTER, EASIER TO HANDLE**

The redesigned, titanium firing platform is a one-piece molded system, compared with the legacy aluminum and steel, multipiece assembly consisting of approximately 200 fasteners with significant welding. An added benefit of the titanium platform: It is 30 pounds lighter than the legacy platform. It also incorporates new carrying handle geometries to increase robustness and carrying comfort. (Photo courtesy of MAJ Wade Perdue, PM TAS)



#### **IMPROVED FIRING PLATFORM**

This design is a one-for-one swap with the legacy platform. Interconnected ribs replace the spikes found on the legacy platform, increasing the platform strength and preventing excessive platform deformation. Holes are added to the new platform shroud, which improves removal from certain types of soil and shortens displacement times. (Photo courtesy of MAJ Wade Perdue, PM TAS)

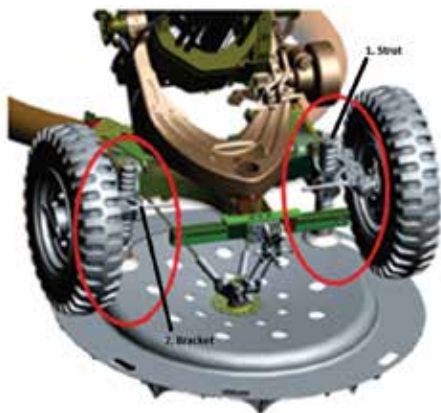

### THE SLOS UP CLOSE

The hardware for SLOS has three main components: struts and brackets, a fixed-recoil system and a titanium firing platform. The struts (1) and brackets (2) are lightweight titanium, easily installable and field-deployable mechanisms that attach to the lower carriage of the howitzer. When the SLOS struts are deployed, the system is adjusted so that there is minimal distance from the firing platform. (Image courtesy of MAJ Wade Perdue, PM TAS)

to industry. This detailed approach resulted in lower technical risk and mitigated potential cost overruns.

In addition to reducing performance risk through well-defined requirements, the team implemented both first article testing (FAT) and first article confirmatory testing in the inspection-and-acceptance portion of the contract.

Incorporating both FAT and first article confirmatory testing can provide a number of advantages, including identifying critical design or manufacturing flaws before executing delivery orders with large quantities. The FAT includes the necessary inspections, tests and documentation to ensure that the product characteristics conform to drawings and specifications within the TDP. The first article confirmatory test is essentially a test of production or production-representative articles under realistic field environment conditions, in this case to demonstrate the strength of the SLOS and the titanium platform and validate that the systems meet the contractual requirements.

### CONCLUSION

Although the Army faces a multitude of uncertainties in the near future from force-structure reductions and resource constraints, the PM TAS/ARDEC team's ingenuity and commitment to excellence not only improved the reliability, availability and maintainability of the howitzer, but also resolved some highly complex technical issues that have plagued the light artillery community for several years.

One of the most significant aspects of these modifications is to expand greatly on the operational capabilities of the field artillery

while using the existing platform. This creative engineering solution allows light field artillery to provide more responsive fires with optimized performance in combat situations requiring high-quadrant elevation and high-charge fires, at a substantial cost savings to the government.

The operational environment continues to be dominated by a hybrid threat and will undoubtedly remain this way. In the future, as in the past, U.S. forces will employ both lethal and nonlethal actions across the continuum of operating environments to safeguard vital national interests. By developing an improvement such as the SLOS and titanium-firing platform, the PM TAS/ARDEC team has set the conditions for light field artillery to meet the challenges ahead.

*For more information, contact MAJ Wade Perdue at [wade.perdue.mil@mail.mil](mailto:wade.perdue.mil@mail.mil).*

---

*MR. JOSEPH LIPINSKI is the M119A3 product director for PM TAS, Picatinny Arsenal, NJ. He holds a B.S. in mechanical engineering from Lehigh University and is Level III certified in both systems planning, research, development and engineering – systems engineering and program management.*

*MAJ WADE PERDUE is an assistant product manager for PM TAS. He holds an M.S. in strategic leadership and management and a B.S. in health care management from The College of West Virginia. He is Level II certified in program management and is a member of the Army Acquisition Corps.*

Want to

# LIGHTEN YOUR LOAD?

Use lithium batteries to increase the operational time of your sensors, lasers and precision targeting devices

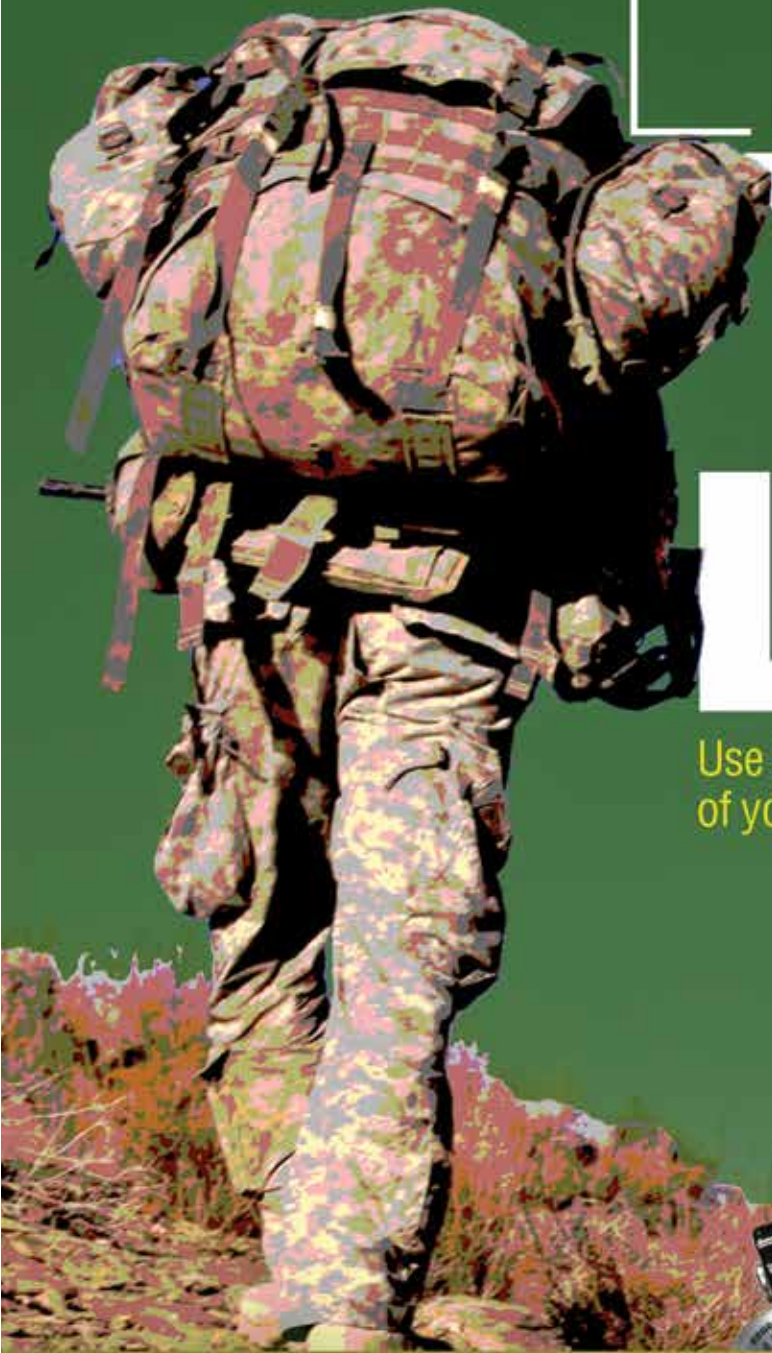

USE  
LITHIUM  
BATTERIES



U.S. ARMY

[peosoldier.army.mil](http://peosoldier.army.mil)



#PowerUpProperly

WHERE DO ARMY AND  
CIVILIAN LIFE COMBINE?  
**THE ARMY RESERVE.**

Transition from active-duty service to the Army Reserve and you may qualify for up to a \$20,000 bonus. You'll get a two-year deployment deferment, and you can learn a new skill to jump-start your civilian career. Plus, there are flexible service options, and you'll get to keep many of the benefits you currently enjoy.

Text ALT to 462769 or visit  
[goarmyreserve.com/alt](http://goarmyreserve.com/alt) to learn more.



**ARMY RESERVE**  
SGT Antwan Smalls  
25U Signal Support Systems Specialist  
Instructor

**CIVILIAN**  
Regional Field Software Engineer





STILL  
↓

# I WANT YOU FOR U.S. ARMY RESERVE

**THANK YOU FOR YOUR CONTINUED SERVICE  
TO THE NATION IN THE ARMY RESERVE.**

Apply your skills and professionalism in the Army Reserve and keep us  
"Total Army Strong." Check out [goarmyreserve.com/sm](http://goarmyreserve.com/sm).



## CONTRACTING

# SPOTLIGHT

## MRS. R. COLETTE CARRIZALES

### A winding road to Texas



#### MRS. R. COLETTE CARRIZALES

**COMMAND/ORGANIZATION:**

U.S. Army Mission and Installation Contracting Command (MICC) – Fort Bliss, TX

**POSITION AND OFFICIAL TITLE:**

Deputy director, MICC – Fort Bliss

**YEARS OF SERVICE IN WORKFORCE:**

18 years in federal service; 13 years in contracting

**AWARDS:**

Achievement Medal for Civilian Service; Commander's Achievement Medal for Civilian Service

**EDUCATION:**

MBA, Trinity College London  
B.S. in business administration and management, California University of Pennsylvania  
Level III certified in contracting  
Member, Army Acquisition Corps

Few career paths follow a straight line, and that is certainly true of Colette Carrizales, who started her career in contracting for the U.S. government as an intern in Seoul, South Korea, with the U.S. Army Contracting Agency. A native of the United Kingdom, she was in South Korea because her husband was a DA civilian employee.

In 2004, the family moved to London, and Carrizales found a procurement job with the London Fire and Emergency Planning Authority (LFEPA) in 2005.

Following 9/11, the U.K. government created the New Dimension program, which spent hundreds of millions of pounds to set up teams and equipment to respond in the event of a terrorist attack, Carrizales said. “They needed an organization to lead this initiative, among other things, in awarding a contract for the maintenance of all this equipment that they had bought.”

At about that time, she said, the U.K. government set up Firebuy to be the procurement agency for the whole U.K. fire brigade. Each county fire brigade had its own procurement arm, and the government “felt that in order to leverage buying power, it would be more streamlined to set up an organization that could purchase items common” to all, Carrizales

said. On behalf of Firebuy, Carrizales was tapped to lead a team of acquisition professionals who would put that maintenance contract into place. The complexity of the requirements was such that the New Dimension program lacked sufficient expertise to develop a contract that would satisfy all stakeholders. In search of a new model, Carrizales explained, they turned to the European Union’s “‘competitive dialogue,’ where you develop a requirement in conjunction with a number of prequalified companies. So, essentially, industry develops your requirement.”

Over many months, Carrizales’ team sat down often with four prequalified vendors, managing the difficult task of keeping vendors and discussions completely separate because of proprietary information issues. Also difficult was “document management, to ensure that discussions had been captured correctly and that each vendor was provided the same information by the government,” she said.

These meetings were resource-intensive and could last all day. Each dealt with different aspects of the contract, from the requirements to the clauses and other terms and conditions, so it was extremely important to have the right people in place at the right time.” The team hammered out the requirements and the contract



with the experts, then awarded a contract without a protest.

The process had not been used in the U.K. before, and at the time only one other agency, the Olympic Delivery Authority, had begun to use it, Carrizales said. Despite having to “self-develop the process” with her team, “it was hugely successful.” The competitive dialogue process validated the technical data in the requirements, enabling the Firebuy team and the potential bidders to check and test the information, which minimized risk for the bidders because the requirements were absolutely clear to both sides. The relationship that developed between the government and the vendor during the dialogue was “immensely valuable to a successful contractual partnership,” and resulted in a “strong contractor [being] appointed in an industry-leading contract following a healthy competitive procurement,” according to the case study that Carrizales wrote for the Office of Government Commerce.

Carrizales thinks it could be valuable for the U.S. government to look at adopting a competitive dialogue model. “Sometimes,” she said, “I feel that we, the government, box ourselves in. We issue requirements with technical expertise but which may not encompass industry best practices. In a lot of cases, when we solicit for a particular product or service, we tend to lay out our specifications, [even when] there may be a better process, a better way of achieving a service, but we don’t know what that is because we don’t keep up—I don’t think—well enough with industry. There are a number of tremendously smart companies out there who are primed and ready to help us achieve what we need.”

In 2010, she and her family moved back to the States, where Carrizales took a contract specialist job at the U.S. Army Yuma

Proving Ground, AZ, before moving to her present spot in El Paso.

### **What do you do, and why is it important to the Army or the warfighter?**

I assumed a new leadership role in late August as the deputy director of the MICC – Fort Bliss office, which contracts for a number of installation-level services and supplies at Fort Bliss. Before this promotion, I led a pre-award contracting division at the MICC – Yuma Proving Ground (YPG) that directly supports the U.S. Army Test and Evaluation Command (ATEC) research and development, and U.S. Army Installation Management Command missions at YPG. The primary mission of YPG is to conduct integrated operational and developmental systems testing and evaluation (OT/DT) in desert, cold and tropic environments at the Yuma Test Center, Cold Regions Test Center and Tropic Regions Test Center, YPG’s subordinate test execution facilities. The MICC – YPG mission is extremely important to the Army and the warfighter, as we contract for services and supplies to enable ATEC to conduct critical integrated OT/DT, independent evaluations, assessments and experiments to ensure that that Soldiers have the right capabilities for success across the entire spectrum of operations. YPG led ATEC for the second consecutive year in the number of direct test hours completed on behalf of the Army test mission, and MICC-YPG has dynamic contract specialists and contracting officers ready to support its test mission 24/7.

### **During your career with the Army AL&T Workforce, what changes have you noticed that have impressed you the most? What change has surprised you the most, and why?**

The Army Acquisition Workforce has changed dramatically over the past 10-plus

years, particularly in relation to processes and training. The acquisition workforce today has to be flexible, knowledgeable and responsive; and possess the ability to implement the ongoing acquisition process streamlining that ensures contracts are awarded in accordance with the myriad federal acquisition requirements. I was impressed by the Better Buying Power initiative and its subsequent versions. It makes perfect sense from a business perspective, and what has surprised me the most is that we didn’t develop and implement such a strategy sooner.

### **Acquisition has changed profoundly in many ways in the past 25 years. How do you see it changing in the future, or how would you like to see it change?**

I would like to see acquisition change with greater engagement with, and involvement by industry. Often, the government has a need but doesn’t know how to achieve the end state. Opening up dialogue with industry and developing an acquisition process like the European competitive dialogue process would resolve some of the issues that the government encounters on some major acquisition programs when it doesn’t leverage best commercial practices or tap innovation because we tend to dictate the requirement.

### **What’s something that most people don’t know about your job?**

Most people don’t know the huge responsibility that a warranted contracting officer has to ensure that the American taxpayer’s money is spent wisely. Also, most outsiders don’t realize the complexity of the major acquisitions that we process and the regulations that we have to adhere to, to ensure that we achieve best value for the government.

—MR. STEVE STARK

## GENTLY SQUEEZE

Tunissha Marshall, a contracting officer (KO) with U.S. Army Mission and Installation Contracting Command (MICC) - Fort Leonard Wood, MO, takes aim while using the Engagement Skills Trainer 2000 marksmanship simulator. ECC's annual OCSJX has evolved over the past five years from a multiservice annual exercise to one that now includes participants from various services and agencies throughout DOD as well as other federal agencies. (U.S. Army photo)





# SKILL SEEKERS

Annual contracting support exercise grows in participation, scope and stature

*by COL Tim Strange, CSM Jesse T. Hammond Jr. and Mr. Cyprien LaPorte*

**T**he operational force's demand for the critical expeditionary contracting capabilities of the U.S. Army Expeditionary Contracting Command (ECC) is growing rapidly year after year. In FY13, ECC, a subordinate command of the U.S. Army Materiel Command, deployed 497 contingency contracting officers to support mission requirements in more than 60 countries across the globe. In FY14, they have been programmed to support 169 critical missions across all geographic combatant command (GCC) areas of responsibility (AORs).

Because of the need to mature professionals in expeditionary contracting, ECC developed a training exercise to help contracting professionals ramp up before they deploy. The first joint training exercise was in 2009, when the 410th Contracting Support Brigade took part in the multinational PANAMAX exercise sponsored by U.S. Southern Command. Similar to what brigade combat teams and other units endure at the National Training Center in preparation for deployment, ECC's annual operational contracting support training exercise (OCSJX) has grown from an internal training tool to one sponsored by the Joint Staff so that contracting support personnel gain the skills necessary should they be called to deploy forward.

DOD's operational contract support readiness has improved greatly with OCSJX, which now includes several coalition partners. In January, 531 contracting professionals from 40 different government agencies and coalition partners participated in OCSJX-14 at Fort Bliss, TX. This year was the first time the Office of the Secretary of



**TEAM ENDEAVOR**

TSGT David Jackson, services KO with Regional Contingency Contracting Team H of the OSCJX-14, explains requirements for a particular service to fellow contracting specialist CPT Camille Morgan at Fort Bliss. The team was practicing operations to improve contracting processes for use after a natural disaster. (Photo by SGT Robert Golden)

Defense (OSD), via the Joint Staff Directorate of Logistics, sponsored the event.

OSCJX-14 participants included the U.S. Air Force; the U.S. Marine Corps; the U.S. Navy; Defense Contract Management Agency; Joint Staff Directorates of Logistics and Joint Force Development; U.S. Northern Command (NORTHCOM); U.S. Army North; Office of the Deputy Assistant Secretary of the Army for Procurement; U.S. Army Sustainment, Contracting, and Mission and Installation Contracting Commands; ECC; and the Contingency Acquisition Support Model (cASM) Program Office, which is maturing a tool to build ready-to-use requirement packages for acquisition and contracting personnel supporting the warfighter. Coalition members from France, Canada and the United Kingdom also participated.

This year, exercise participants provided operational contract support for a NORTHCOM natural disaster training scenario, testing the procurement forces' capability to respond to a major earthquake damaging an eight-state region in the central United States. The exercise helped prepare contracting professionals to deploy at a moment's notice to support any mission worldwide, whether the situation is a natural disaster or a man-made crisis.

**WORKING SMARTER**

According to BG Michael D. Hoskin, ECC commanding general, "understanding that our defense enterprise as a whole and our Army in particular are facing an extremely challenging resource environment, we are focused at increasing the capabilities of our organization rather than just focusing on its size.

"To continue to grow as an organization, we are fully committed to leveraging established and emerging contracting tools and technologies, as well as the most advanced training platforms. We are also committed to ensuring that we have the processes in place to be a true learning organization. Because we execute contracting missions in more than 60 countries annually in support of all GCCs and Army service component commands, we need to constantly learn and propagate what we've learned across our entire organization. We're going to have to work increasingly smarter as an organization to accomplish our expeditionary contracting missions in our emerging resource environment."

Working smarter means training in the same environment as contracting professionals would in the field and that means training in a joint environment.



#### CAREFUL CARRY

2d Lt, left center, Danny Monroe, SFC David Grider, SFC Michael McTague and Joaquin Tucker, lift a “casualty” onto a litter during a medical evacuation exercise at the Medical Support Training Center on Fort Bliss, TX, during OCSJX-14. EEC established the exercise to increase contracting professionals’ capabilities in both expeditionary contracting and battlefield survival. (U.S. Army photo)

Hoskin said no other DOD exercise addressed the operational contract support process to the extent and with the rigor that OCSJX-14 did. It marked the first time the DOD workforce linked multiple logistic support contracting efforts into one exercise: the Air Force Contract Augmentation Program (AFCAP), Logistics Civil Augmentation Program (LOGCAP) and the Logistic Services Contract of the Federal Emergency Management Agency, all of which DOD officials would work with in this type of scenario.

OCSJX-14 participants, in working through the simulated natural disaster scenario, practiced developing and validating requirements packages, reporting the status of contractors on-site, tracking

the impact to the mission and operationalizing contracting support to meet the commander’s intent, all by providing hands-on training from seasoned mentors guiding new contracting professionals at the exercise. This is the type of training that helps ECC grow skilled professionals in all forms of contracting support.

#### SKILL SETS

The joint exercises are designed to train both the contracting and noncontracting members of the workforce, Hoskin noted. “This is the first time we created tasks at the strategic level to work COCOM [combatant command] staffs to think about acquisition laws and rules for which they may want waivers from OSD and Congress to effectively accomplish

the mission,” he said. As an example, he continued, it is important to know what the trigger would be for the COCOM to ask the deputy chief of staff of the Army, G-4 for the authority to execute the LOGCAP and the Air Force for authority to execute the AFCAP global contracts in support of this mission. These exercises explore such situations.

The core themes of OCSJX-14, which focused on growing the next generation of OCS professionals and leaders from all services, were to train and improve OCS capabilities and warrior tasks for all participants.

The exercise tested participants’ skills in two phases. The first phase involved five

**“BECAUSE WE EXECUTE CONTRACTING MISSIONS IN MORE THAN 60 COUNTRIES ANNUALLY IN SUPPORT OF ALL GCCs AND ARMY SERVICE COMPONENT COMMANDS, WE NEED TO CONSTANTLY LEARN AND PROPAGATE WHAT WE’VE LEARNED ACROSS OUR ENTIRE ORGANIZATION.”**

days of warrior task training designed to keep contingency contracting officers alive on the battlefield. In this phase, military and civilian participants received weapons familiarization, vehicle-rollover training in High Mobility Multipurpose Wheeled Vehicle and Mine Resistant Ambush Protected vehicle simulators, convoy operations training in the Close Combat Tactical Trainer and two days of medical skills training.

The second phase of training focused on topics unique to contingency operations. This phase included instruction on contingency acquisition policy, ethics, procurement fraud, payment procedures, paperless contracting files, the Contracting Officer’s Representative Tool, public affairs and the Joint Contingency Contracting System, part of a suite of contingency contracting tools offered by the Defense Procurement and Acquisition Policy Office.

It is vital to train not only military members but also DOD civilians because they are part of the acquisition team, and anyone may be called upon to deploy forward, Hoskin said. The training in OCSJX ensures that all those who might have to go in harm’s way to accomplish an OCS mission are prepared for anything that can happen in any environment.

Many DOD civilians who volunteered for operational contract support

assignments in Iraq and Afghanistan had not received any warrior task training. As a result, many were ill-equipped for what they would confront and see while performing their roles in hostile environments. OCSJX addresses that deficiency and boosts participants’ confidence in their ability to complete their acquisition mission in a stressful environment.

### CONCLUSION

At any given time during OCSJX-14, participants were accomplishing two different mission sets. As they were completing warrior task training, NORTHCOM officials were completing their acquisition requirements packages in support of the scenario. These packages then went to contracting teams, which began executing the contracting mission. There were 16 contracting teams, each with 10 joint members, and each team had more than 200 requirement packages to execute in about two weeks.

OCS is not only about contracts, however; it is also about requirements development. OCS involves teaching customers how to better develop their requirements; how to build an acquisition package, a performance work statement and a quality assurance surveillance plan; and how to identify needs for a successful contract that gives the requiring activity all it truly needs.

OCSJX is the escalation of the OCS concept, starting by making sure the workforce is trained to do its mission and then adding new pieces to the training each year. It is a long-term, deliberate approach to how DOD is doing OCS and requires the commitment of every agency involved.

For more information, go to <http://ocsjx14.tumblr.com>.

*COL TIM STRANGE, 412th Contracting Support Brigade commander, Joint Base San Antonio (JBSA) – Fort Sam Houston, TX, was the executive director of OCSJX-14. He holds an MBA from Western Carolina University and a B.S. in engineering from the United States Military Academy at West Point. He is also a graduate of the U.S. Army Command and General Staff College and the Joint and Combined Warfighting School. He is Level III certified in contracting and Level I certified in program management. He is a member of the Army Acquisition Corps (AAC).*

*CSM JESSE T. HAMMOND JR., 412th Contracting Support Brigade command sergeant major, was the senior enlisted contracting adviser for OCSJX-14. He holds an M.S. in management from the University of Management and Technology and a B.S. in business administration from Liberty University. He is Level III certified in contracting and a member of the AAC.*

*MR. CYPRIEN LAPORTE, chief, Contract Plans and Programs Division, MICC, JBSA – Fort Sam Houston, was the deputy director for OCSJX-14. He holds an M.S. in materiel acquisition management from the Florida Institute of Technology and a B.S. in criminal justice from Cameron University. He is Level III certified in contracting and a member of the AAC.*



# OPPORTUNITY · RESPONSIBILITY · IMPACT

## U.S. ARMY CONTRACTING COMMAND

### Contracting: Enabling the Decisive Soldier

Utilize your skills as a Soldier in the acquisition workforce and help meet the Army's increasing need for contingency contracting officers in the modular force. Noncommissioned officers can apply for Military Occupational Specialty 51C, Acquisition, Logistics and Technology reclassification with the U.S Army Acquisition Support Center; while officers can apply with the U.S. Army Human Resources Command.

- Receive career development, training and advancement.
- Support the ongoing war effort, humanitarian missions and operations worldwide.
- Attain career field certification and enroll in education opportunities.
- Rise to the challenge to accomplish critical missions.
- Lead a small team achieving significant results.
- Provide needed technology, supplies and services for our warfighters.

[WWW.ACC.ARMY.MIL](http://WWW.ACC.ARMY.MIL)





## CRITICAL THINKING

# ‘SEMPER GUMBY’

A former Marine recruiter’s job with Starbucks is all about connection

Chat with Starbucks’ Tom Tice awhile about his job, and you get the impression that the retired Marine is like a kid in a candy store when he goes to work each day. It’s not the caffeine talking; he is just that enthusiastic about what he does. Now he’s working to recruit some 10,000 former military personnel and active-duty military spouses to become Starbucks partners—the employees who provide what the company calls the Starbucks Experience.

Tice started his career as a Marine in the late 1980s as a heavy machine gunner, then served duty in U.S. embassies before becoming a recruiter. In that capacity, he said, he never quite knew what a day was going to be like. It could have been helping people with no family military history understand what it means to be a Marine. Or dealing with people of very different cultures while working in U.S. embassies in Africa and South America. In the midst of that ambiguity, he sought to create connection.

Tice loved being a Marine. “It was very fulfilling, and every day was a new challenge. [I] absolutely loved the Marine Corps. It was a privilege to earn the title of U.S. Marine, and it was a privilege to have served with America’s finest.”

When he retired from the Marines in June 2009 as a master sergeant after more than 20 years of service, he spent 2 ½ years as a stay-at-home dad and, while he loved that experience, he said, it was a very tough job. When he and his wife, Brandy, were expecting their second child, he decided to look for a new career. He started at Starbucks as a contract employee in early 2012 and found that his military skills and training fit well with the company. That October, he was hired full time as a manufacturing recruiter.



**Tom Tice**  
Starbucks Corp.  
Manager for Military  
Recruitment







**THE 'BIG EASY' DOES IT**

Starbucks captures the look and spirit of the French Quarter of New Orleans, LA, as well as the city's history as a coffee trading port, at its Canal Street store, which opened a year ago. Starbucks makes a point of designing its stores with the community and local motifs in mind. (Photo courtesy of Starbucks Corp.)

“You come to work at Starbucks, and every day is a little different,” he said. “You might have a plan, but you’ve got to change”—not too different from being a Marine recruiter. Now, as he recruits veterans and active-duty spouses, he sees the need for similar skills: “I think just being versatile and being able to be—in the Marine Corps we called it ‘Semper Gumby.’ Here we call it just [being] flexible.” Tice thinks that veterans and active-duty spouses, whether from the Marine Corps or not, bring a lot of that valuable Semper Gumby spirit to the company.

For Tice, the common theme throughout his careers—as Marine recruiter, stay-at-home dad, Starbucks’ manager for military recruitment—is connection, that is, creating understanding among people who otherwise might not understand the Marines or Starbucks. “[Starbucks’] core values are very similar to [those of] the military. I often say that in the Marine Corps, the two objectives of leadership are mission accomplishment and troop welfare. And [at] Starbucks, the two objectives of our business are legendary customer service and taking care of partners. And they just match so well.”

Here’s the in-depth discussion that Army AL&T had with Tice on Aug. 28.

**Army AL&T:** Starbucks has been around in its present state for more than 25 years. What are the biggest changes the company has seen in its workforce since then? How have you adapted (your training, your recruiting, etc.) as a result?

**Tice:** Our partners—what Starbucks calls its employees, [which number some 300,000]—have always been at the core of our business. For over 40 years, we have hired passionate people who create inspired moments of connection with

our customers every day. Although the company has grown, what has remained the same is our commitment to investing in the people who create the Starbucks Experience for more than 70 million customers per week, in more than 21,000 stores in 65 countries around the world. From beverages, such as the pumpkin spice latte that customers look forward to every fall, to locally relevant store designs, such as our New Orleans store, which honors the artistic spirit of the community, we’re always looking to preserve and encourage the human connection with every decision we make.

We hire and retain great people and are always looking for top talent and the right cultural fit to ensure our future success—people with a passion for coffee, service and their communities. When you come

in, you should have this wonderful encounter with our partners and really have an engaging interaction. Starbucks is about a journey, and the Starbucks Experience is kind of that journey you have within our stores.

We call [the stores] snowflakes, because they’re each designed with the community in mind that they will serve or be a part of. Starbucks is huge in being a part of [the local] community. So bringing that design element to that store with the outlying community piece is integral, and ensuring that we capture what’s there [in the community] to provide that Starbucks Experience in its entirety. We have regional offices with designers in them that go around looking at where we’re going to either remodel or build a new store. They have a formula where they



**SINGULARLY STARBUCKS**  
Every fall Starbucks offers its pumpkin spice latte to warm the season, not to mention strengthening its brand identity with customers.  
(Photo courtesy of Starbucks Corp.)



#### ASIAN APPEAL

Starbucks' store in Famille Park in Seoul, South Korea, which opened in August, is a geometric glass dome designed to evoke an "urban coffee forest" within the city. Starbucks offers a variety of locally sourced foods and beverages at the Famille Park store. The company opened its first South Korean store in July 1999 and now has 680 stores in the country. (Photo courtesy of Starbucks Corp.)

look at the communities and really try to capture the elements and essence of that community.

Starbucks made the strategic decision to hire 10,000 military veterans and active-duty spouses by the end of 2018. Our leaders recognize the considerable skills and experience that veterans and military spouses could bring to our business, and the fact that more than 1 million American service members will be returning to civilian life over the next few years. In addition to [creating] my

role as a dedicated military recruiter, we have increased our presence at military job fairs and placed a number of veterans and military spouses into roles in a wide range of opportunities that leverage their leadership, discipline and operational experience. More importantly, we are keenly focused on building the team, tools and culture to support our initiative and ensure that we do all that we can to properly on-board veterans and military spouses. Hiring is just the first step. We are also focused on retention, [because] keeping the military and

spouse candidates will provide our company long-term benefits.

**Army AL&T:** You refer to your employees, talent, associates, human capital, etc., as "partners." What gave rise to this terminology, and what does it mean to Starbucks?

**Tice:** The term comes from the fact that our employees are partners in every sense of the word—how we conduct our business and how we treat others. In 1991, the company introduced Bean Stock, which



‘INSPIRED MOMENTS OF CONNECTION’

From the opening of its first store in 1971, Starbucks has set out to be a different kind of company, one that celebrates not only coffee but also a feeling of connection to the community. (Photo by Catherine DeRan, U.S. Army Acquisition Support Center)

turned eligible Starbucks employees into partners by providing the opportunity to share in the financial success of the company through Starbucks stock. Bean Stock was the first program of its kind in the retail industry. It encouraged partners to act like owners of the business and share in the company’s success. In FY 2013, partners enjoyed \$234 million in pretax gains from Bean Stock.

**Army AL&T:** Other restaurants known for coffee, such as Dunkin’ Donuts, are franchise operations. Starbucks doesn’t really franchise. About 40 percent of stores are licensed in the United States—for example, a store you might find in an airport—and about 48 percent on average worldwide. What are the implications, or benefits, for the partners at the majority of Starbucks’ stores?

**Tice:** Going back to our partners being the core of our business, Starbucks CEO and Chairman Howard Schultz has long recognized that having company-owned stores makes it easier for the company to build trust with those partners. We own and operate the stores and take accountability for them. As such, our partners trust the company, in turn making it easier for them to build trust with our customers. For those stores that are licensed, the licensee is a trusted business partner and represents our brand well. We are proud to be at the front of the relationship with our customers.

Starbucks does really well taking care of their partners. So there’s not a whole lot of need for change in the area of retention. ... We’re [always] looking at what we can do. We take care of the partners so well with the Bean Stock—and if they stay with us, they get more vacation time, and now [we have] the College Achievement Plan.

There's nothing specific for the military veteran and spouse yet, but we are reviewing that. [But] the added value that we've noticed from the military is they tend to stay with us longer, or transfer from location to location. Because Starbucks is in all those locations, we have a great opportunity [for the active-duty spouse] to be in just about every geographical location. But, also, we have such flexibility of times. At Starbucks, a partner can start at 4 a.m. or 6 a.m., depending on the store, and we have part-time roles available. One thing that Starbucks has always done is, that, at 20 hours a week as a part-timer, you receive full-time benefits.

And with a spousal candidate being able to receive Bean Stock and vacation time at 20 hours a week, having them come to work for us and having that flexibility, that geographical option—one of the things that I've noticed is that spouses, every time they're PCSing [undergoing a permanent change of station], stop working for a short period of time. They take care of their family, get the kids back in school, whatever it may be to set up their environment there, and then they try to look for employment again. And it's a restart. So we really want to encourage our spouses [to understand] that we have that geographical footprint, we have flexibility of time, and with that comes the potential to be retained for a long period of time. It really kind of reduces for us that period that would be necessary to train partners, because we have this survivable talent pool that can move across different areas.

**Army AL&T:** You have a military background. What was your field? What, if anything, do you think it brings to your work with Starbucks?

**Tice:** My military background is somewhat diverse. I enlisted in the Marine



#### REACHING OUT

Devin Craig, second from right, a district manager for Starbucks Coffee Co., and his team run a booth at the Boots 2 Work Military Career Fair in Tacoma, WA, Aug. 27, to talk to Soldiers and veterans. Starbucks aims to hire 10,000 military veterans and active-duty spouses by the end of 2018. (U.S. Army photo by SGT Cody Quinn, 28th Public Affairs Detachment)

Corps and served as a heavy machine gunner with 1st Battalion, 7th Marines, where I served in Operations Desert Shield and Storm and Operation Restore Hope. I then was accepted to serve tours at the American embassies in N'Djamena, Chad, and La Paz, Bolivia. I attended the Supply and Administration Course, after which I supported Headquarters Marine Corps for two years as the supply and logistics chief.

During the last few years before I retired, I represented the Marine Corps and recruited for enlisted [personnel] and officers in the Seattle area. I also helped train new recruiters throughout the state of Washington. This latter tour of duty was especially helpful when I started my job search and started working for

Starbucks, but everything I've done has prepared me to work here. I think the most important piece of my background that made the biggest impact, is that while I was on recruiting duty, I handled a lot of ambiguity daily, dealing with a lot of variety. Learning to navigate around different workplace situations has helped me transition to civilian culture.

As a Marine recruiter, you're embedded with the community. You work with high school students, college students, but you also have to navigate high school teachers and principals and counselors and family members. It's unfamiliar territory for some if they've never served. We have a small population of America that has served in the military. So a lot of it is truly trying to give them the information



#### GLOBAL MONTH OF SERVICE

Throughout April of each year, Starbucks' "partners," its employees, volunteer in the communities where they work. Starbucks views its Global Month of Service program as a vital element in its efforts to build strong connections. For 2014, Starbucks partners logged 232,000 hours on nearly 1,700 projects. (Photo courtesy of Starbucks Corp.)

and educate them on what the military is, and a piece I think I brought from my military time as a recruiter into Starbucks is very similar. Having to navigate an unknown for somebody else, or share a story or develop that [story], has really helped me here [at Starbucks to] tell a bigger story, specifically in recruiting.

**Army AL&T:** Starbucks started out rather humbly but has become a worldwide operation over the last 25 years, with stores in 65 countries. What have been the implications of that growth from a workforce perspective?

**Tice:** To get from fewer than 100 employees less than 30 years ago to a global workforce of several hundred thousand now, we've had to build expertise in sourcing, logistics, roasting, farming, human resources, finance and, most especially, in hiring and training partners who can create the Starbucks Experience in stores globally. As the workforce is ever-changing, we always look to hire the best candidate for the right position. That can be challenging depending on the position, and as we enter new lines of business or grow into new markets, we have to find the experience that we might

lack. Here in the United States, one of the ways we've overcome that challenge has been through our Military Hiring Initiative. Since that initiative launched, we've had an overwhelming response from the community that helps us grow our business and further diversifies our workforce, delivering value to our shareholders and the communities we serve.

We understand that to be successful in other markets [globally], we have to create store experiences that are inspired by the culture and passions of the community. We hire store partners who will

connect with the community where they work, whether that's speaking the local language or engaging with every customer to create inspired moments of connection. For corporate positions in our support centers, many of our partners speak English as well as the local language. That allows us to create global training and bring local experiences to other markets.

**Army AL&T:** With sequestration and budget uncertainty, the Army, not to mention the federal government, can sometimes seem like not the most attractive employer. What can the Army learn from Starbucks with respect to retention of valued people?

**Tice:** I can remember going through periods of furloughs [when I was in the Marines], and I clearly recall the heavy impact it can have on the government, military and the people who work for public institutions. I know that as a result of sequestration, some personnel opted to transfer from the public sector to the private sector. This loss of talent negatively impacts the operational effectiveness of any organization. Realizing that retention isn't always possible, understanding how to keep those who can adapt and grow while staying engaged is essential. Providing opportunities for our partners to grow and develop is critical to retention. We are committed to developing our partners to become leaders and to influence beyond their own store and role, leaders who can make a significant, positive impact for our business, each other and our world.

**Army AL&T:** How do Starbucks people affect its policies? For example, when employees find a better way of doing something, how does that get to the top so that it becomes a standard practice? Can you provide an example or two?

**Tice:** We have a few ways we encourage our partners to make positive changes. In our stores, we empower our partners to bring new ideas to the table that lead to innovation for the company. For partners in all our locations, not just stores, we have the MyStarbucksIdea site, a place where partners can share their ideas. In 2011, Starbucks saved between \$5 million and \$10 million because of an idea a store manager shared that eliminated waste with our whipped cream. Our leaders also make a point to visit stores regularly and hear what is top-of-mind for our partners. They are looking for the on-the-ground insights that will help us create an even better experience for our customers, as well as ways to improve the partner experience.

We have a board downstairs on our fifth floor that is kind of like "My Partner Idea," and it's a running tally of partners submitting better ideas. And this particular one with the whipped cream saved millions of dollars. I forget the exact total, but there are hundreds of ideas that partners will submit that really help develop the company from the ground up and really taught [us] that our partners are important in everything that we do. So it's really a partner-centered company that loves that innovation.

You're familiar with the espresso machines with the hoppers on top that we pour the coffee beans into? At one point those hoppers and machines were larger, and it was hard for the barista to actually see the customer. We want the interaction, the customer experience, to be more of a flow so that, when they designed the machine, they designed it so that you could see past the hopper, for the barista to be able to engage with the customers.

**Army AL&T:** Army acquisition personnel must have legally mandated (by the Defense Acquisition Workforce Improvement Act) training, education and experience within a set timeframe, unlike most of industry. What routes or programs do Starbucks employees have to advance through the ranks? How, for example, does a barista become a manager [and] become an executive, and does it differ by country?

**Tice:** We are dedicated to training our partners and providing them with opportunities to excel and promote. To advance at Starbucks, partners need to demonstrate a passion for what we do. In addition to the training we provide our baristas to prepare them to be promoted to a shift supervisor, to an assistant store manager and on to a store manager and so on, we look for ways to provide

**WE'RE ALWAYS LOOKING TO PRESERVE AND ENCOURAGE THE HUMAN CONNECTION WITH EVERY DECISION WE MAKE. WE HIRE AND RETAIN GREAT PEOPLE AND ARE ALWAYS LOOKING FOR TOP TALENT AND THE RIGHT CULTURAL FIT TO ENSURE OUR FUTURE SUCCESS — PEOPLE WITH A PASSION FOR COFFEE, SERVICE AND THEIR COMMUNITIES.**

**WE ARE COMMITTED TO DEVELOPING OUR PARTNERS TO BECOME LEADERS AND TO INFLUENCE BEYOND THEIR OWN STORE AND ROLE, LEADERS WHO CAN MAKE A SIGNIFICANT, POSITIVE IMPACT FOR OUR BUSINESS, EACH OTHER AND OUR WORLD.**

our partners with life-changing, global experiences. These opportunities include our Global Month of Service [program], where partners volunteer in their communities in the month of April, [and] the Origin Experience, where partners travel to one of our coffee farms to learn how we're building long-term relationships with farmers and their families. Coffee started in Ethiopia and has migrated into a lot of countries around the equator. It really is like a pilgrimage. It's kind of a journey of understanding coffee and its holistic nature. It's really cool. I've not been. I've seen a lot of pictures from others who have gone, and they're absolutely moved by some of the places and people they meet.

And [then there's] the Leadership Experience, where store managers come together to build on their leadership skills.

Additionally, Starbucks is dedicated to helping our partners further their career at Starbucks or wherever they aspire to go by completing their education. Earlier this year, we announced the Starbucks College Achievement Plan, a significant partnership with Arizona State University that will enable our U.S. partners to complete their bachelor's degree with full tuition coverage. Our partners will have the ability to choose from more

than 40 undergraduate degree programs. We believe that our partners will have a rewarding career at Starbucks, but we also recognize our partners have aspirations in other fields. That's why we are not requiring partners to stay with Starbucks once they have completed their degrees.

**Army AL&T:** The Army likes to “grow its own” acquisition experts, preferring to recruit out of college and grow into future program leaders. Does Starbucks follow that model and, if so, how do you maintain the career path from barista to corporate leader?

**Tice:** It is essential that all of our partners understand and embrace the culture that makes us successful. Those partners who have the experience of working at the store level often have a more complete understanding of that culture, but we also work to provide that exposure to partners who join us from other organizations. It is also important to Starbucks to stay at the forefront of innovation, from our mobile platform to our store designs to our customer service. Bringing in new talent from diverse backgrounds helps us to tap into the imagination of our teams.

**Army AL&T:** Do Starbucks people develop any of the equipment that Starbucks uses or any of the merchandise that

Starbucks sells? If so, is there a Starbucks research and development function? If not, how does Starbucks acquire the tools of the trade?

**Tice:** Starbucks develops much of what we use on a daily basis in our stores. We have an in-house design team that drives the look and feel of our stores and merchandise. We do purchase some equipment, such as our Mastrena espresso machines, but we are constantly working toward new developments and technologies within the company, and are on the lookout for new technologies. We think that our in-house teams are well-equipped to develop new tools and processes because they know our culture and how important our customers are to the brand.

**Army AL&T:** What else can you tell us about Starbucks' military recruitment program? What kind of a priority is it for the company?

**Tice:** This is a top priority for the company. Not only are veterans exceptionally well-trained, but they have strong work ethics and highly valued, transferable skills and leadership. We want to leverage this considerable amount of leadership, discipline and operations experience and give ample opportunity for veterans to transition from the military. Another opportunity are the 1.2 million active-duty military spouses. As a result of moving frequently, military spouses come from diverse backgrounds and bring with them many qualities and skills that would translate well into a career at Starbucks. With more than 21,000 stores in 65 countries, Starbucks would have the opportunity to retain military spouses when they move.

It's an amazing honor to be a part of ... making the connection between the military community and Starbucks.



**Army AL&T:** How did your own military experience prepare you to work at Starbucks in the various segments you've worked in?

**Tice:** My many experiences in the Marine Corps have uniquely positioned me to handle a wide range of opportunities at Starbucks. I believe the intangible aspects of creative problem-solving, influencing without authority or navigating an ambiguous environment have been critical to my development as a leader. The people skills I acquired during my service have been a tremendous asset to my post-service career, which has included manufacturing recruiter, partner (human) resource manager and recruiting manager.

**Army AL&T:** Are there any similarities between military recruitment and recruiting for Starbucks?

**Tice:** When it comes to military service, only a select few aspire to give of themselves unselfishly in order to serve our great nation. Yet I find that our partners without military experience have a very similar desire to give of themselves to serve the communities where our stores are located. Our CEO, Howard Schultz, often states how proud he is of our partners for their willingness to go above and beyond, and I feel like Starbucks is another extended family. No matter where I travel, be it Germany, San Antonio, San Diego or right here in my hometown of Seattle, when I visit a Starbucks store I am amazed at the value our partners bring to the community and how inspiring they are on a daily basis!

[Schultz] is known for having open forums, and he'll tell a story or bring someone in. When we made the announcement [of the Military Hiring Initiative], we had a couple of partners who had previous military

experience, who transitioned out of the military and had just started working with us. One of them was in the Austin, Texas, area or in the southern Texas area, and his name was Ty. He had just gotten out of the Marine Corps. He'd been a sniper, he was a single dad and he was going back to his home. And we flew him up and Howard met him, shook his hand. We introduced him in the open forum during [the shareholders' meeting at the announcement of the initiative], and Ty was a person that epitomized the value of our partner—who he was, what he's done and what he was doing for himself, going above and beyond being a single dad and going back to school, working and being a part of a greater community and what that all represented. I think that's a perfect example on a daily basis of how much Howard cares about his partners—that he would go to Texas and find somebody that was really relevant and honor them in that fashion.

When I recruited for the Marine Corps, we always recognized that becoming a United States Marine was an admirable goal and an opportunity that was rewarding for those who served. While certainly not the same, the chance to become a partner with Starbucks is also a great opportunity and can be incredibly rewarding. Starbucks' core values and mission statement are key indicators of this similarity. At both places, being committed and passionate is an important quality, and having had the opportunity to work with both institutions, I can identify those qualities in my recruiting.

**Army AL&T:** Starbucks has bucked the trend of the last couple of decades—instead of building an online business, the company has built brick-and-mortar shops seemingly everywhere. Your website calls Starbucks “a place for conversation

and a sense of community.” How does the company view its partners' role in that?

**Tice:** While Starbucks has been incredibly innovative in the digital space, as a leading mobile payment company with a strong digital identity, we continue to build our physical presence. As I've mentioned, we won't be successful without the right partners. We put a lot of thought and resource into the designs of our locations, taking the local community into the account so that we can provide a place that is relevant to each market. Once in our stores, that's when our partners begin to establish and nurture relationships with our customers, providing great service and high-quality food and beverages. It is a combination of both design and community that creates comfort, and our partners are the cornerstone of the store community.

[In addition], the fact that you can download an app, put it on your phone and walk up to a cashier and pay with that app has been one of the key things that people love about coming in the stores. So you can scan that in and tip your barista as well. So that's pretty key to the digital world, as it's some of the first of its kind.

**Army AL&T:** What does the future hold? What are the biggest issues you'll face? What excites you most?

**Tice:** From a recruiting perspective, making it clear that Starbucks is a place where partners can learn skills that will work for them well beyond their Starbucks career is a priority.

I am motivated by the opportunities for our military service members, veterans and spouses to become a part of such a company that views the social and corporate responsibilities through a lens of humanity. ?

# SPOTLIGHT

MS. JUDY COLE

Performance  
improvement imperative



## MS. JUDY COLE

### COMMAND/ORGANIZATION:

Program Executive Office for Ground  
Combat Systems

### POSITION AND OFFICIAL TITLE:

Lean Six Sigma process improvement  
specialist

### YEARS OF SERVICE IN WORKFORCE: 4

### AWARDS:

U.S. Army Lean Six Sigma Master  
Black Belt, Achievement Medal for  
Civilian Service

### EDUCATION:

B.S. in mathematics, Oakland  
University

For Judy Cole, a Lean Six Sigma process improvement specialist at the Program Executive Office for Ground Combat Systems (PEO GCS), Better Buying Power (BBP) 2.0 “really helped bring focus on what to work on, what priorities an organization needs to have [in order] to set goals on what you need to accomplish. And I think it helped to empower people to say, ‘Yes, this is what we need to be doing.’ ”

Cole, a Michigan native, spent 20 years working in performance improvement in the automotive industry before moving into her civilian acquisition position. “My experience in the automotive industry provided me with outstanding opportunities for training,” and offered considerable room for professional development, she said. “I held positions in many different functions including manufacturing, engineering, quality, market research, sales and marketing.” This wide-ranging background prepared her to “take a holistic look at an organization and apply best practices here in PEO GCS,” she said.

In 2008, she took a job with a government contractor and worked at the Tank Automotive Research, Development and Engineering Center (TARDEC) in support of business transformation using Lean Six Sigma (LSS). While at TARDEC, she applied for a Master Black Belt position at PEO GCS and got it. At PEO GCS, she became a U.S. Army Lean Six Sigma Master Black Belt, and part of her current work is teaching and mentoring other acquisition professionals.

“You can apply Lean Six Sigma to many different industries,” she said. “It’s really big in health care now, automotive and even banking. It’s the same methods and tools, just applied to different industries.” Improving a process, product design and quality, or customer satisfaction will improve the overall performance of the organization, she said.

For Cole, BBP 2.0 has been something of a call to arms for LSS professionals, helping their cause by clarifying leadership priorities and providing a system for

*I have noticed a greater focus on process discipline and sharing information and best practices across organizations.*

focusing their efforts. “Once leadership sees it as a priority and they support it, then it’s much easier to get everybody on the same page and working toward the same goals.”

That said, LSS projects don’t just come from leadership and then trickle down. “There are two ways that we come up with projects,” Cole said. “From the bottom up and top down. From the top down, we want to look at our strategy, metrics and goals, and where we are falling short. For example, we found that the time required to staff our acquisition documents was impacting and delaying contract awards. We found there was considerable rework of these documents as they went through the staffing process. We launched a Lean Six Sigma project that improved the process of developing the acquisition documents up front by using a cross-functional team. This process improvement eliminated much of the rework downstream and enables us to staff documents faster.”

But efforts also come from the bottom up. For example, she said, “One of our engineers from [the project management office for] Stryker noticed large crates of scrap wheels while visiting one of the depots. They saw waste. They launched a [Lean Six Sigma] project by forming a cross-functional team of depot and staff employees, and they were able to eliminate that waste.”

In addition, she said, “we have several projects that are using Lean Six Sigma and Design for Six Sigma methods and tools to upgrade our Abrams tank electronics and power line replaceable units, or LRUs. This enables us to proactively identify and reduce operations and sustainment costs by influencing up-front design decisions.” These projects, she said, will have a significant impact on

the cost of supply and maintenance of Abrams tank LRUs, with estimated financial benefits of \$126 million over seven years.

Cole said that LSS lends itself to nearly every aspect of BBP 2.0, which “helps you achieve your organization’s goals. We need to do things faster, better, smarter and at less cost. That’s the end goal of Better Buying Power.”

**What do you do, and why is it important to the Army or the warfighter?**

As the Army Master Black Belt for PEO GCS, I lead PEO GCS in implementing Lean Six Sigma methods to improve our processes and deliver affordable, capable ground combat systems to the joint warfighter. I ensure that we select the most important projects that will enable PEO GCS to achieve our objectives and goals. Through the use of LSS, leaders and teams make decisions based on data and analysis to gain greater efficiency, productivity and satisfaction among our partners and stakeholders.

With reduced resources, it is even more important that we successfully execute efficient processes that deliver high-quality capabilities on time. We need to do things faster, better, smarter and at less cost.

**During your career with the Army AL&T Workforce, what changes have you noticed—in processes, training, equipment, etc.—that have impressed you the most? What change has surprised you the most, and why?**

I have noticed a greater focus on process discipline and sharing information and best practices across organizations. I am impressed with the passion and commitment of leadership and the workforce to

reduce costs and eliminate redundant or inefficient processes. There is a sense that we are all one team and we need to work together and share ideas and resources to accomplish our mission.

**What’s the greatest satisfaction you have in being a part of the AL&T Workforce?**

It is very rewarding to work with such a diverse team with a vast range of skills, knowledge and experiences. As a Master Black Belt, my responsibilities include teaching and mentoring teams to solve problems. I learn something new every day from everyone I work with.

**Acquisition has changed profoundly in many ways in the past 25 years. How do you see it changing in the future, or how would you like to see it change?**

Through focused strategies like BBP, we will continue to provide affordable world-class capabilities much faster than we have in the past. In an ever-changing world, our Soldiers need us to accelerate our ability to provide new capabilities, using new technologies.

**What’s something that most people don’t know about your job? What surprises outsiders most when you tell them about your job?**

Continuous performance improvement opportunities exist across the entire life cycle, whether it is in the design, manufacturing, logistics or sustainment of our vehicles. Everyone has the opportunity to make improvements in their area, which ultimately helps the warfighter.

—MR. STEVE STARK



# COST IS KEY

Kendall and Gansler praise workforce,  
urge affordability as a requirement

SOURCE: Topp Yimgrimm/iStock/Thinkstock

*by Mr. Steve Stark*

“**W**hat do we plan for?” That was former Undersecretary of Defense for Acquisition, Technology and Logistics (USD(ATL)) Dr. Jacques S. Gansler asking a rhetorical question about the problems that defense acquisition faces. The venue was the Aug. 5 Defense Acquisition Modernization Symposium hosted by the Armed Forces Communications and Electronics Association in Washington, DC., Gansler’s topic was doing more with less and planning for contingencies when DOD knows it’s not going to have much money to plan around—but also doesn’t know how much it will have.

Gansler is now the first to hold the Roger C. Lipitz Chair in Public Policy and Private Enterprise at the University of Maryland’s School for Public Policy. His talk followed a morning keynote by the current USD(ATL), the Hon. Frank Kendall. Gansler, often mordantly humorous in his luncheon talk, left government after many years of service, and could play the academic to Kendall’s all-business executive. But Gansler was serious as he confronted the present and foreseeable difficulties that defense acquisition faces, which are many, from budget uncertainty and drastically reduced government research and development funding, to globalized technology, instability and cybersecurity threats.

“The world is unstable,” he said. “There are very few countries that aren’t seeing either cybersecurity issues or regional instabilities or local instabilities or whatever. The world is a mess.”

With that in mind, Gansler said, “A good question is, ‘What do we plan for?’ Well,” he continued, “If you’re going to plan for things, you have to recognize that if you don’t know what to plan for, then you’d better be able to move fast. And if we take 20 years to develop something, we can’t move fast.”

### CHALLENGES, SOLUTIONS

Increasingly, Gansler said, moving fast is something that the U.S. government has a good deal of trouble accomplishing. “The government used to be the leader in research investments, and yet today industry is spending more than twice what the government spends on research.” And, as the United States has long relied on technological superiority as its chief advantage over its adversaries, that advantage is slipping. “How do we more rapidly respond and, since our strategy literally has been technological superiority, how can we maintain that position?” The answer is, in part, he said, to be able to take full advantage of technology available globally and commercially.

If Gansler outlined all of the challenges faced in acquisition, it fell to Kendall to try to lay out the solutions. His presentation, “Better Buying Power: Do We Have It Right?” examined BBP’s successes, shortcomings and future. Kendall said that he is concerned about “affordability problems” as a result of sequestration. But even without those, affordability has to be baked into the requirements of every program.

His predecessor echoed that in his talk. “I always hear the military say,” Gansler said, “ ‘Cost isn’t one of our requirements.’ Well, it is, actually, because cost determines quantity, and quantity is clearly a military requirement.” Gansler said that cost should “be an engineering



### ADDRESSING THE CYBER THREAT

Soldiers from the Georgia Army National Guard train at the Georgia Tech Research Institute, which played a key role in the Georgia Guard’s success in amplifying its cyber defense capabilities. The growing cyber threat is just one challenge that defense acquisition faces, complicating the issues of planning and budgeting. (Photo by Renita Folds)



### MOVING TECH FORWARD

President Barack Obama announces two new public-private Manufacturing Innovation Institutes and launches the first of four new Manufacturing Innovation Institute Competitions, at the White House Feb. 25. Future iterations of Better Buying Power are likely to place a greater emphasis on research and development as well as collaboration among acquisition, the technology community and end users. (Official White House photo by Lawrence Jackson)



**EXPANDED ROLE**

Representatives from URS Federal Support Services attended the 2014 Midwest Small Business and Government Contracting Symposium at the iWireless Center in Moline, IL, on May 7. According to Kendall and Gansler, small businesses will have a big role to play in pushing the innovation that's vital to helping the United States maintain its technological edge. (Photo by SFC Shannon Wright, ASC Public Affairs)

requirement and a production requirement and a support requirement.”

Indeed, Kendall said, agencies and services have to “determine whether programs are really affordable or not before they start them, so we don’t waste a lot of money on false starts.”

**SHOULD-COST**

Kendall went on to say that one of “the most fundamental tools we’ve put in place for our managers is something called ‘should cost’ in BBP 2.0. “The idea of should-cost,” he continued, “is very simple, and if you live in the corporate world, you understand this very well. Managers are responsible for their costs. You should be doing whatever you can while you’re trying to accomplish your mission to control your costs and drive them down. To do that, you have to understand your costs, you have to analyze them and look for opportunities to reduce costs and set targets for yourself

to achieve” those opportunities. Should-cost, he said, “applies to programs, it applies to service contracts, it applies to whatever we’re doing.”

Describing BBP 2.0 as a “never-ending process” of performance improvement, Kendall illustrated the kind of thinking he’s trying to change with the initiative. He was working with one of the services, “basically buying an off-the-shelf helicopter, and we could’ve gotten a small helicopter or a large helicopter.... The large helicopter was going to give us better performance, but the small [one] was going to meet our threshold. I said that it might be the best value for us to get the large helicopter if it’s cheap enough. ‘How much more are you willing to pay for it?’ ” he asked the service. “And they would do a cost estimate. And I said, ‘No, that’s the wrong question. I don’t care what it’s going to cost. I care what you’re willing to pay for it. What is the value of it to you?’ ” he said.

Which was, he said, his point to all of the services: to think about “what they were willing to pay for something as opposed to what they thought it would cost.” The importance of doing that is not just to get the services to nail down the value of a capability to them, but also to provide industry insight into what the services need, Kendall said, which it can then use “to make informed judgments about what to bid to us, and it gives industry a reason to bid above the threshold to give us more performance, to be innovative.”

With U.S. technical superiority in decline—the French, Gansler said, have the lead in night vision because they’re able to procure global and commercial products, and the Israelis have the lead in armor for similar reasons—it’s tremendously important that DOD leverage all the innovation and technical edge that industry can provide.

Kendall said he intends to find ways to better leverage industry’s independent research and development (IR&D), and that the next iteration of BBP would emphasize that more. “I’ve asked some of the larger companies to come in and brief me personally on their IR&D plans so that I can give them feedback,” Kendall said, “and I’ll have the service acquisition executives with me when we do that.” BBP 3.0, expected this fall, will focus on getting DOD “back to our products and what we deliver to our warfighters,” Kendall said at the annual ComDef 2014 conference Sept. 3 in Washington. “It’s going to be about innovation [and] technical excellence.”

Industry isn’t the only party that needs to be innovative, Kendall noted. The services, he said, must use all the contract vehicles at their disposal to provide incentives for industry to develop better solutions. He noted that the next iteration of BBP

would include partnerships between acquisition and requirements and among acquisition, technology and the operating communities, “so all those communities are working together to help speed transition of technology back to the warfighter.”

### THE IMPORTANCE OF COMPETITION

Kendall also emphasized the value of competition. “It’s the best single thing we can do to get costs down for the government.” He quickly noted that competition is not always possible, “but where we can ... have head-to-head, direct competition, we’ll continue to create what I call ‘competitive environments’ ” in which companies have to “worry about somebody taking your business.” That, he said, keeps companies on their toes and makes them better—not only for DOD but for their other customers as well.

Gansler agreed, noting several studies showing that competition among vendors during the 1960s and 1970s had reduced net costs by 12-50 percent. He also pointed up the difference between the way that DOD procures services and materiel, joking, “Do you think that buying an engineer is the same as buying a tank? ... You don’t put the engineer through live-fire testing.” Buying tanks, services and information technology are vastly different, he said, and there should be different practices and policies for each. However, “all of our practices, all of our policies are built around buying goods, and yet more than 50 percent of dollars go to buying services.”

According to Kendall, the procurement of services will continue to get a lot of attention. “I think we’re making progress,” he said, “but there’s more to be done.” Small business will continue to be a part of that, he said, as well as a part of pushing innovation.

### THE PROFESSIONAL WORKFORCE

In improving the professionalism of the workforce, Kendall said, the Defense Acquisition Workforce Improvement Act requirements have become bureaucratic, and he’d like to do away with some of the “check-the-box approach to demonstrating proficiency in acquisition.” He’d like to see more meaningful ways to demonstrate proficiency. Acquisition, he said, is a fundamentally “human endeavor” that requires great professionalism and expertise to do well. “That’s true across a lot of career fields. It starts in engineering and engineering management and program management. ... There are a number of places where professionalism really matters.”

Integral to the development of that professionalism, he said, is the continued funding “of DAWDF, the Defense Acquisition Workforce Development Fund. ... This fund has become so important for building professionalism. It was used initially to increase the size of the workforce. It is being used now to make key hires for key losses. ... It’s also being used now a lot for training, for improving professionalism. DAWDF is enormously valuable to us. So we don’t need as large a fund...but keeping it going, I think, is a very, very helpful thing.”

Gansler expressed concern about the loss of qualified acquisition professionals, “not just for DOD but across the overall government. ... The aging workforce is ...



### FILLING THE GAP

Ssg Jason Mitchell works with CW2 John Galeotos during the 2014 Cyber Shield exercise at the Professional Education Center in North Little Rock, AR, May 2. While DAWDF and other measures have been effective in improving the professionalism and training of the acquisition workforce, attention must be focused on replacing retiring members with qualified, experienced personnel. (Photo by CPT Kyle Key)

**“THE GOVERNMENT USED TO BE THE LEADER IN RESEARCH INVESTMENTS, AND YET TODAY INDUSTRY IS SPENDING MORE THAN TWICE WHAT THE GOVERNMENT SPENDS ON RESEARCH.”**

a real issue in terms of the experienced people retiring out, and what we’ve been doing is replacing them with interns. So, across the overall federal government, the acquisition workforce, 50 percent of the people—in the case of DOD, 55 percent of the people—have less than five years of experience, but they’ll learn,” he said.

“And these senior people who are retiring,” he continued, “aren’t being replaced by people with experience. ...That’s clearly saying that we’re not valuing [the workforce] as much as we need to.”

**IMPROVING OUTCOMES**

The latter half of Kendall’s talk was aimed at ways to improve acquisition outcomes, which mirrored a letter he sent to Sen. John McCain, R-AZ, on June 13 and outlined several steps Congress could take. The first step, he said, is to “end the threat of sequestration,” a comment that was greeted with loud applause from the audience. “If there is anything that is killing us today, it is the threat of sequestration. I’ve lived in a nightmare budget environment for the last few years.”

Unfortunately, he said, “It’s coming right back in 2016,” and “we’re going through an exercise this fall where we’re [first] going to look at what [budget] the president is going to submit and [second] something that’s in line with sequestration and see what the damage is. The damage is huge. You compound that with all the cost-savings we’re asking Congress for [but] they’re not giving us.”

“The number one thing that can be done to help acquisition and help the department is to get rid of sequestration, and we’re going to have to continue to make that case,” Kendall said.

Next on his list was simplification of the rules and regulations surrounding defense acquisition. He complimented Rep. Mac Thornberry, R-TX, who is leading the House Armed Services Committee in an initiative to simplify some of the rules, bureaucracy and confusion in the regulations.

“Let’s simplify the rules we have. Let’s not put more in place,” Kendall said. He’s most interested in fixing rules that dictate acquisition procedures or strategies and restrict the amount of time an acquisition program must take. “We do such a wide variety of things that we need the flexibility to tailor how we do things to the problem we’re trying to solve. ... It’s very important for people to think critically about their programs and tailor them to what they’re trying to do. No two programs are the same.” Avoiding restrictive rules will “let us make the best decisions we can.”

The next item on Kendall’s list was the need to reduce the counterproductive incentive to obligate funds for fear of losing them. “This is ... the idea that your job is to spend money.” It’s not, Kendall said. “Your job is to get value. If it takes a little bit more time to get value, I want people to take that time. I don’t want us

to get into the situation at the negotiating table where we’re looking at the clock [and] thinking, ‘I’ve got to get this contract closed because the comptroller or the Hill is going to rescind my money.’ ... I want the other guy to be worried about that, not us.”

Kendall described his last item as “sort of wishful thinking. I don’t think there’s much likelihood that this will happen, but I put it on the table because I think it would be very helpful, and that is to allow or even require services and agencies to hold a management reserve to be applied when problems arise,” he said.

“Development is inherently risky,” he continued, and it’s not possible to budget for risk so that there would never be a cost overrun or delay. “But I want to put reasonable pressure on people to do a good job and execute.” With this management reserve, Kendall said, when there is a problem, he could apply that reserve efficiently and not penalize or kill another program that is meeting its targets to pay for the problematic program. The development phases of programs “will get into trouble. Smart program managers always put some reserve in. This is a more strategic reserve.”

---

*MR. STEVE STARK provides contracting support to U.S. Army Acquisition Support Center for SAIC. He holds an M.A. in creative writing from Hollins University and a B.A. in English from George Mason University. He has worked in a variety of positions supporting communications for the Army and Navy, and has written about defense-related topics for more than a decade. He was the founding editor of the Program Executive Office Soldier Portfolio and edited the Army’s Weapon Systems handbook for six years.*





# TIMES CHANGE



*your*  
**BATTERIES  
SHOULD  
TOO**

Use lithium batteries to increase the operational time of your sensors, lasers and precision targeting devices



## USE LITHIUM BATTERIES



**U.S. ARMY**

[peosoldier.army.mil](http://peosoldier.army.mil)



#PowerUpProperly



## COMMENTARY

FROM THE DIRECTOR,  
ACQUISITION CAREER MANAGEMENT  
LTG MICHAEL E. WILLIAMSON

# IN IT FOR THE LONG HAUL

The work done by the Army Acquisition Corps makes a difference far into the future



**A**s we celebrate the 25th anniversary of the Army Acquisition Corps (AAC), it is clear that the AAC's work has lasting implications and lasting effects. As I look back on my association with the AAC, I could not be more proud of what we have accomplished. Nor could I be more certain that the men and women of the AAC, and the Army Acquisition Workforce as a whole, are the right people to meet the challenges of an uncertain future.

This silver anniversary is a good time to take a wide-ranging look at how far the AAC has come and where we're going, while answering many of the questions I hear frequently from members of the workforce, be they students at the Defense Acquisition University (DAU) or the Army Acquisition Center of Excellence, or seasoned product and project managers in our program executive offices.

**Q.** At this 25th anniversary of the Army Acquisition Corps, we would like to hear about the reasons you joined the AAC.

**A.** I came into the Army as an Air Defense officer, and at that time, I thought my greatest achievement would be to become an O-5 battalion commander. To me, that was success. My dad retired as an E-8 in the U.S. Air Force, and my

joining the military was a big deal for me and my parents. The opportunity to become an officer and ultimately command a battalion seemed to be the culmination of all of my career dreams.

When the Army started the Acquisition Corps, I was an automation officer (Functional Area 53). In fact, I was pulled out of Air Defense and into the Acquisition Corps. However, any disappointment I may have had didn't last long. I was given the opportunity to be the product manager for the Global Command and Control System – Army. Up to that point, I had not spent much time in a product office, so my first year was a huge learning curve.

It was the early part of Operation Iraqi Freedom, and we were in Kuwait, dealing with a limited infrastructure. I saw the command, control and communications improvements we were able to put in place and realized the significant effect decisions made by product managers and program managers have on the Army. Today, as I look back at the systems that I touched and have been a part of, I appreciate the impact I was able to have serving in the Acquisition Corps. Our work is long-term. We build systems that may be used by generations of Soldiers. Sometimes, people don't realize the long-term nature of our work.



### CLEARING THE WAY

A Husky IED-detection vehicle, assigned to the South Carolina Army National Guard's 1221st Route Clearance Company, leads a convoy during route clearance operations at McCrady Training Center, Eastover, SC, June 24. The development of vehicles like this one demonstrates how an agile acquisition workforce and a responsive industrial base can work together to meet the urgent needs of Soldiers in combat. (U.S. Air National Guard photo by TSgt Jorge Intriago)



**Q.** What are some of the changes you have seen, with all your experience, in the Army Acquisition Corps? Is there a better understanding of acquisition today?

**A.** The Acquisition Corps was created in 1989 to improve the quality of military and civilian acquisition specialists. Our Acquisition Corps members today—and members of the greater acquisition workforce—are much better-trained and -educated than members were in the early years. After 13 years in Iraq and Afghanistan, they are far more experienced, too. We also have more streamlined processes to get capabilities to the Soldier rapidly, and a healthy industrial base to support us.

During the last quarter-century, our professionals have had an increasing role in keeping our Army the greatest land force on earth. I believe that today's Army has a clearer understanding of the role of the acquisition community in mission success.

For example, when Operation Enduring Freedom began in 2001, the Stryker Brigade Combat Team was only a vision, and the Double-V Hull was not even a part of that vision. Improvised explosive devices (IEDs) reminded us that the enemy has a vote. To meet this new threat, there were new requirements. We up-armored the High Mobility Multipurpose Wheeled

Vehicle and eventually procured the multiservice Mine Resistant Ambush Protected (MRAP) vehicles and the MRAP All-Terrain Vehicle for greater levels of protected mobility. The urgent needs of our Soldiers were met by a hard-working, agile acquisition workforce and our equally responsive industrial base partners.

In 2001, few had heard of Army unmanned aircraft systems. Now, Raven, Shadow and Gray Eagle are vital components of the battlespace, with more than 2 million flight hours recorded, 90 percent of them in combat. Additionally, in the early stages of Operation Iraqi Freedom, operations outpaced our communications equipment. Today, leaders can execute mission command on-the-move from tactical vehicles equipped with Warfighter Information Network – Tactical Increment 2, and we have added software-defined radios and Nett Warrior handheld devices that deliver the power of the network to the individual Soldier. In every program executive office and across all portfolios, there are success stories about capabilities delivered to meet Soldier needs.

These changes allowed Army acquisition, along with our industry partners, to make a huge difference in the lives of our Soldiers.

**Q.** As the director of acquisition career management, what are your priorities?

**A.** My highest priority is ensuring that our Soldiers have the weapon systems, equipment, products and services they need to do their jobs. To do that, we need the right acquisition professionals with the right skills in the right place at the right time to meet Soldiers' needs, and that is why talent management is so important. This process of managing our talent must be deliberate and coordinated to optimize leader development practices and align talent with current and future Army requirements, improving both the individual and the organization. Identifying, growing and developing our acquisition human capital are essential to the success of our Army acquisition programs.

We must provide our professionals with developmental opportunities to enhance their skills, experience and leadership abilities. Crucial to creating leaders is proper on-boarding of our acquisition personnel and retention efforts to ensure that high-performing and high-potential personnel make acquisition their career. Establishing and setting expectations through the use of standardized career models is also a key to successful talent management. The three-tiered Acquisition Career Development Model—functional competencies, career broadening and



### IMPROVING OPERATIONS

Preston Propes, a machinist in the Systems Integration and Support Directorate at Tobyhanna Army Depot, PA, has developed improvements that saved more than 75 direct labor hours over a six-month period by using basic Lean Six Sigma principles. The foundation of the acquisition community is a smart, professional and passionate workforce that is committed to providing capabilities to Soldiers. More than ever, that also means looking for ways to work more efficiently and effectively. (Photo by Steve Grzedzinski, U.S. Army Communications-Electronics Command)



### MAKING IT HAPPEN

Soldiers from the 4th Battalion, 23rd Infantry Regiment, 2nd Stryker Brigade Combat Team (SBCT), 2nd Infantry Division evacuate casualties June 26 during Decisive Action Rotation 14-08 at the National Training Center, Fort Irwin, CA. When Operation Enduring Freedom began in 2001, the SBCT was only a vision. With the support of the AAC, that vision became a lifesaving reality remarkably quickly. (U.S. Army photo by SPC Charles Probst, Fort Irwin Operations Group)

strategic leadership development—balances the development of leadership skills while serving the needs of the Army with acquisition expertise.

In the near term, we will be piloting an opportunity for high-performing acquisition civilians identified with leadership potential to fill product director (PD) positions. Our plan includes a developmental track facilitating the achievement of a PD, follow-on positions after a successful tenure as a PD, and guidance all the way to the Senior Executive Service. The creation of these centrally selected PD positions will provide more opportunities for leader development and growth of our high performers to meet the future needs of our force.

Certification of our acquisition workforce remains paramount. We have done impressively well in this regard, with 88.1 percent of our Army acquisition workforce certified. Another 9.4 percent are within the grace period. So, currently 97.5 percent of our acquisition workforce is certified or within the grace period. This is phenomenal, but we cannot stop there. It is important to ensure that our workforce professionals are taking the right steps to get the training, education and experience required to be certified—and that they are participating in continuous learning opportunities, as 80 continuous learning points (CLPs) are required every two years. We are ending our current two-year cycle on Sept. 30, and a new cycle begins on Oct. 1. It is crucial to remain current and relevant, which makes the attainment of CLPs so critical.

In addition, we have leadership development opportunities such as our Acquisition Leadership Challenge Program (a two- to three-day program assessing leadership competencies at entry, mid-, and senior levels); our

Competitive Development Group/ Army Acquisition Fellowship Program (a three-year developmental program for GS-12/13 equivalents); and our DAU Senior Service College Fellowship Program offered regionally at Warren, MI; Huntsville, AL; and Aberdeen, MD. We also offer tuition assistance programs for our acquisition personnel through the Army DACM Office of the U.S. Army Acquisition Support Center's (USAASC).

The use of the Defense Acquisition Workforce Development Fund (DAWDF) to develop innovative training programs that target Army acquisition human capital initiatives and address gaps in our acquisition functional competencies has been instrumental in meeting established goals. DAWDF-funded programs have supported the improvement of certification rates, the building of functional and leadership development skills, increased attainment of acquisition core competencies, and the recruitment, retention and recognition of our best acquisition workforce talent.

**Q.** Can you talk a little more about your new PD pilot effort?

**A.** There is a barrier to entry into Centralized Selection List (CSL) positions for our acquisition civilians, and I recognize that we have not articulated a clear program management path to success for them. My intent is to increase the number of civilians managing acquisition programs and to offer a centralized selection process for them to obtain cost, schedule, performance and management experience. As I mentioned, I am working with the USAASC to pilot this opportunity in FY15, to gather lessons learned and to offer opportunities for civilians in three main categories: geographically, regionally and centrally.

Civilians could be centrally selected, similar to the DA Secretariat CSL process, and decide to work in their own backyards or explore opportunities geographically. The availability of jobs is key, and we are working to ensure that after a three-year tenure in a PD, the follow-on assignments and developmental opportunities are awaiting these personnel who are stepping forward to take on these challenging acquisition responsibilities.

**Q.** How would you describe your leadership style?

**A.** I have been described by others as a strategic leader. It is important for me to empower others to take the reins and ensure that a mission stays on task. Simply put, I want people to think through their choices and understand the short- and long-term impacts of their decisions.

Another aspect of my leadership style is that I try to always be accessible. I prefer conversations rather than briefings. I like to get out and talk to the staff about the projects they're working on. I learn more about what is going on in my organization in one trek around the office than from several briefings. I'm not a big fan of email. I prefer to meet face to face or to pick up the phone and talk directly to someone.

I believe leaders have a responsibility to mentor; we need to share experiences, knowledge and thoughts. It is important to me that our workforce professionals succeed programmatically, professionally and personally. I often tell our program managers that they need to be the smartest people in the room when it comes to their programs, because there are a lot of people who think they know the programs better than the program managers do. My experience is that, in the absence

## DETECTING THREATS

The U.S. Army's Edgewood Chemical Biological Center (ECBC), working with the U.S. Army Communications-Electronics Research, Development and Engineering Center and the Defense Threat Reduction Agency, has developed a new way to quickly evaluate potential chemical and biological threats using smartphones, an encrypted reader and volatile organic compound (VOC) detection strips. The proliferation of low-cost technology available to the enemy means that the Army must remain agile and adaptive to new threats. (Image courtesy of ECBC)





#### TESTING THE LIMITS

During Network Integration Evaluation (NIE) 14.2 at Fort Bliss, TX, July 23, MAJ Stephen Dail, brigade communications officer with the 2nd Brigade Combat Team, 1st Armored Division (2-1 AD), and CPT Jason Patterson, 2-1 AD information system management officer, explain how the WIN-T system works to COL Terrece Harris, director of the capability package. The semiannual NIEs are a hallmark of Army Acquisition's quest for greater agility in developing new and innovative technologies to meet warfighters' needs. (Photo by Vanessa Flores, ASA(ALT) System of Systems Integration Directorate Public Affairs)



#### EAGLES, RAVENS AND SHADOWS

Gray Eagle unmanned aircraft systems (UAS) await maintenance Aug. 12 in the recently opened Fort Hood UAS Maintenance Hangar at Robert Gray Army Airfield, TX. Gray Eagle, along with Raven and Shadow, are fixtures in the battlespace, having notched more than 2 million flight hours, mainly in combat. (Photo by SSG Christopher Calvert, 1st Air Cavalry Brigade, 1st Cavalry Division Public Affairs)

of facts, other people will create them for you. That is something we cannot allow to happen. My advice is to be the best at what you do and, as leaders, support your people's success.

**Q.** What are some of the major issues that you deal with on a daily basis?

**A.** I find that I spend most of my time dealing with industrial base issues and personnel issues: What kind of force will we need? What are our modernization priorities? How do we ensure that we have the right people to design, build and procure warfighter capabilities in 2020, 2025, 2040?

As we work to answer those questions, we are continuing to modernize and build new equipment as required. Acquisition is an ongoing process to make sure we are ready for new threats and the next mission.

**Q.** What is the major challenge facing Army acquisition?

**A.** The budget is obviously a concern for DOD and for the Army in particular. However, I think the real budget challenge is stability in funding. Predictability for our programs and our industrial base partners is vital. Another major challenge is ensuring that we have an innovative, agile and experienced workforce to rise above any fiscal situation and identify ways to get things done for our Soldiers.

In the current environment, we have to find new ways to be more efficient and effective. As I've stated, ensuring that we have the right people with the right skills in the right place at the right time is critical. Anything short of that jeopardizes our ability to deliver capabilities to our warfighters.

History informs us that we are going to be in another fight. The proliferation of low-cost technology means that we must remain agile and adaptive to new threats. If our Soldiers need capability “x” and they need it tomorrow, we must be ready, along with our industry partners, to provide it as quickly as possible. My main concern is not that the enemy will outdistance us in terms of technology. My fear is that access and low costs give our future adversaries more parity. This is unacceptable. Our ability to counter new threats is among our greatest challenges.

**Q.** We’ve heard you talk about the importance of leaders, from product and program managers to program executive officers, addressing issues that keep them up at night, taking care of those they can and seeking help from experts for others. What keeps you up at night?

**A.** People and the industrial base—those are the two things that keep me up at night. We must ensure that we have the human capital—the developers and program managers, the scientists and engineers, the information technology, contracting and other acquisition professionals who are experienced and understand how to do things very quickly, efficiently and effectively.

What makes us unique is having a smart, professional and passionate workforce that is committed to providing capabilities to our Soldiers. Nurturing, challenging and developing that workforce is my greatest concern. Without a first-class workforce, we can’t develop, deliver or support the warfighter. Also, ensuring that we have a strong relationship with our industry partners, not only for the weapon systems and equipment we are building and upgrading today but also for those products that are on the horizon.



**ALL THE NEWS**

USAASC’s Office of the Director, Acquisition Career Management provides the acquisition workforce with easy-to-find, actionable information on education, training and development. Identifying, growing and developing the right people for the workforce is essential to the success of the Army’s acquisition programs. (SOURCE: USAASC)

**Q.** What is your intent with the new writing campaign? How is it going?

**A.** Our first writing competition was launched earlier this summer and just ended on Sept. 15. This important endeavor was recently dedicated in memory of MG Harold J. “Harry” Greene, a great Soldier, leader, mentor and friend who inspired all of us to tackle complex problems on behalf of Soldiers. Having this writing award named after Harry is just one way to honor him and his many contributions to the Army.

We received numerous entries in this year’s four categories: lessons learned; future operations; acquisition reform/Better Buying Power; and innovation. The essays, articles and opinion pieces

submitted are now being judged by a distinguished panel of experts from government, media, private industry and academia. Four winners will be selected, one in each category, along with four honorable mentions.

My intent here is to create a venue for critical thinking about Army acquisition. Too many times I hear or read opinions from people two steps removed from actual practitioners. These pundits and self-declared experts lack the knowledge to opine, but they wax poetic about our business. My goal is to have practitioners take a hard look at the past, present and future of Army acquisition. I’m pleased that plans are underway for next year’s competition.

**CONNECTING TOMORROW'S WARRIORS**

The Army's new family of tactical radios does a lot more than push to talk. More like miniature computers, the radios use secure, high-bandwidth waveforms to send voice, data, images and video, even past terrain obstacles and beyond line of sight.

# NOT YOUR FATHER'S RADIOS



**RIFLEMAN RADIO**  
Single-channel radio running the Soldier Radio Waveform (SRW) that connects to Nett Warrior devices so Soldiers can use mission apps, send messages and track one another's locations.



**MANPACK RADIO**  
Two-channel radio that can run SRW, SINCGARS, UHF SATCOM and MUOS to serve as a "bridge" from the Rifleman to the Army network—fielded in vehicle-mounted and dismounted versions.



**MNVR Mid-Tier Networking Vehicular Radio:**  
Runs SRW and the Wideband Networking Waveform (WNW), for new "mid tier" in the network, connecting brigade and battalion with company and platoon.



**SALT Small Airborne Link-16 Terminal:**  
Connects the Apache helicopter to brigade and below with real-time voice and data via SRW, and provides voice and the joint air picture via Link 16.



**SANR Small Airborne Networking Radio:**  
Uses SRW, WNW and SINCGARS for air-ground data, voice and video comms with Apache, Kiowa Warrior, Chinook and Black Hawk helicopters, and Gray Eagle Unmanned Aircraft.

PEO C3T is using a Non-Developmental Item approach to procure commercially developed radios that use government-owned waveforms. This competitive radio marketplace will drive industry innovation, leading to superior radios for Soldiers at lower costs.







9 September 2014

## TO THE MEMBERS OF THE ARMY ACQUISITION CORPS

On the occasion of the Silver Anniversary of the establishment of the Army Acquisition Corps, I want to offer my congratulations and thanks to each of you – military, civilian and family member. 25 years ago when I signed the letter formally creating the AAC, the Army was faced with an ever-expanding range of challenges in the acquisition field. Procurement systems had grown increasingly complex, demanding that we navigate the labyrinth of regulations, processes and requirements, and our internal organization needed to adapt to respond to these challenges.

By the late 1980s, it had become clear that the Army needed a cadre of professionals – both military and civilian – who were experts in the acquisition process and in all of its ancillary requirements. It was equally clear that these professionals, who were already seasoned in a succession of staff and command assignments, needed a separate and dedicated career track that would hone their skills at increasingly higher levels of responsibility, provide for focused education and development, and keep each individual competitive for selection and promotion with the members of the other branches in the Army. Those circumstances led inexorably to the need for the Army Acquisition Corps, and I was proud to direct the AAC's formal establishment in January of 1990.

Since those first days, the AAC has consistently demonstrated its value to the Army and to the nation. Through the hard work of all of you, the AAC has been instrumental in the continued modernization and sustainment of the Trained and Ready Army of today. Each soldier and civilian in the AAC should take justifiable pride in what the Army Acquisition Corps has achieved in its first 25 years of service. You have served the nation with dignity and honor.

Happy Anniversary.

Handwritten signature of Carl E. Vuono.

Carl E. Vuono  
General  
United States Army (Retired)

### IN THE DRIVER'S SEAT

In this 2007 photo, Harry Hallock, then executive director, Army Contracting – Warren, takes a Terex Super Stacker with a loaded container for a test drive while on a contracting cell site visit to Sierra Army Depot, CA, part of the U.S. Army TACOM Life Cycle Management Command. (Photo courtesy of the Office of the Deputy Assistant Secretary of the Army for Procurement (ODASA(P)))





FROM THE DEPUTY ASSISTANT  
SECRETARY OF THE ARMY  
FOR PROCUREMENT  
MR. HARRY P. HALLOCK



# TIME TO THINK

Technology, demands of war have sharpened contracting workforce; now it's time to reflect on what's next

In October 1989, the U.S. Army formally created its Acquisition Corps. I don't recall this action as earth-shattering or monumental, but it was a time of celebration, as the contracting career field was now considered a professional job series within the federal government. So, after working in Army contracting for 10 years, I was now considered a "professional."

While studying business administration at the University of Delaware in the late 1970s, I hadn't even considered a federal career; I really didn't know what I would do after graduation. In truth, business wasn't my first choice, but my parents and my high school principal convinced me that I could earn a good, consistent living with a business degree. As it turned out, they were right. After college, I took the Professional and Administrative Career Examination, and started as a GS-5 with a two-year internship at what was then the Department of Army Development and Readiness Command (now U.S. Army Materiel Command). The Army recruited

me into an organization called TARCOM—the U.S. Army Tank-Automotive Materiel Readiness Command, now the TACOM Life Cycle Management Command—in Warren, MI, and I never looked back. Army contracting quickly became a passion.

At the time the Army Acquisition Corps was stood up, we were still contracting by using hard-copy check sheets and antiquated word processing systems to fashion documents that routinely exceeded 1,000 pages. Copy machines really got a workout in those days. I'm sure those who grew up in the information age are shocked at the thought of such archaic practices and wonder how we managed to meet the tight deadlines that exist today. Expectations were different then, based on the available technology—or lack thereof.

Just because technology allows us to do things instantaneously doesn't mean we have to, however. Even in these fast-paced times, with a





**MASTERING THE ART OF PROCUREMENT**

Hallock and the Hon. Heidi Shyu, the Army acquisition executive, discuss strategy at a cooking competition held in conjunction with the Principal Assistant for Contracting 2013 Summer workshop hosted by the ODASA(P) in Washington, DC. (Photo by Kathie Scarrah, ODASA(P))

plethora of automation tools that allow us to do everything faster and presumably better, we must stop at critical points in the process and think about what we're doing and why.

**CALLED TO DUTY**

From the beginning of my career, I recognized my good fortune to work at a weapon systems command where I could learn the many types of contracting, including spares, research and development, installation and, of course, buying weapon systems. My goal was the same as for any contract specialist today: to support our troops. It was especially satisfying to know that my hard work had a positive impact on our Soldiers in battle and, more important, helped to bring them home alive.

A decade into my career, a typical day for me included reviewing requirements packages and interacting with the customer—a host of government support personnel without whom we couldn't function, including legal, financial

management, logistics and engineering personnel, as well as support organizations such as the Defense Contract Audit Agency, Defense Contract Management Agency, Defense Finance and Accounting Service and others. I also interacted with offerors interested in our solicitations and others with whom we already had contracts. In all cases there were questions to be answered, clauses to be explained and problems to be solved. Days were full, and it was rare that one ended with our having completed what we had thought we would accomplish when the day began. Inevitably, one or more “crises” sent us off in a totally different direction.

And then there was that midnight telephone call on a cold Michigan night in January 1991. Operation Desert Storm had begun that day, Jan. 17, and when I left the office late that afternoon, I had no idea I'd soon be back working with the entire TACOM weapon system team in direct support of TACOM and the U.S. Central Command (CENTCOM)

leadership on this emerging crisis. By then, I was a GS-13 contracting officer who worked hard and slept even harder, so I was a bit out of sorts when I received the call from the TACOM Operations Center. The command needed me back in the office immediately. At 0400, the TACOM commander, then-MG Leo J. Pigaty (who retired in 1994 as a lieutenant general), was scheduled to brief GEN H. Norman Schwarzkopf, the CENTCOM commander, who required several thousand Heavy Expanded Mobility Tactical Trucks to be moved into theater within hours; the force needed more tactical vehicles than originally contemplated in support of the M1 Abrams tanks and the M2 Bradley Fighting Vehicles.

The challenge was tremendous. Transporting these vehicles by ship was out of the question, as it would take too long; CENTCOM needed these vehicles for the initial surge. I woke up my counterparts at Oshkosh Truck Corp., and we began the process of determining options and laying out courses of action. The solution—air transport—quickly became obvious, but the execution was not so simple; it would involve TACOM, U.S. Army Materiel Command, the Air Force, the U.S. Transportation Command, industry and many others.

We prepped MG Pigaty, and by the time the briefing to CENTCOM began at 0400 EST, the TACOM team, along with our compatriots across DOD, were able to lay out a plan that required Oshkosh to drive completed vehicles some 90 miles to General Mitchell International Airport in Milwaukee, WI, where Air Force C5A aircraft, flown there for this mission, would ship the vehicles directly to theater. I returned to my desk around 0430 and promptly fell asleep. There, a fellow employee found me the next morning, sound asleep, head on my desk well ahead



#### FROM THE PENTAGON

Federal News Radio host Jerod Serbu interviews Hallock on May 14 at the Pentagon, for “On DOD,” a weekly one-hour show that focuses on the programs and policies that affect the Defense Department. (Photo by Kathie Scarrah, ODASA(P))

of when a typical day at the office should have begun.

I have never served in the military, nor has the Army asked me as a civilian to deploy in a “boots on the ground” capacity, but I can say that the pride and exhilaration I felt that night as the contracting officer in direct support of those at the tip of the spear gave me a sense of accomplishment that I will never forget. Jan. 17, 1991, was my personal testament that our actions in contracting make a difference and contribute to the success of our men and women who serve in uniform. I am reminded of this every day as I see the tremendous effort our contracting workforce puts forth and the amazing successes.

#### EFFECTIVENESS AND EFFICIENCY

Before Operations Enduring Freedom and Iraqi Freedom, we didn’t have the

pressures and challenges of learning “on the go,” as so many of our contracting professionals do today. We tended to think of our business in terms of efficiency more than effectiveness. The dollar amount of obligations and the number of contract actions executed back then were about one-fourth of what our folks must execute today.

We didn’t realize how significant an impact downsizing the workforce in the 1990s would have on contracting actions some 25 years later, or how the workload pendulum would swing back so dramatically as we contracted for contingencies in two theaters at the same time, all while technology and automation made the job faster if not necessarily easier. As a result, we didn’t allow for an orderly plan to downsize the workforce; frankly, we had no concrete expectation that the pace of contracting would increase.

During the wars in Southwest Asia, Congress stood up the Special Inspector General for Iraq Reconstruction, the Commission on Wartime Contracting and the Special Inspector General for Afghanistan Reconstruction—three organizations with oversight of our contingency contracting efforts—to assure the American public that we were contracting smartly and were being held accountable. These and other oversight organizations found that the Army was relatively proficient in executing contracts but delinquent in administering them, especially in oversight of the large number of service contracts that directly supported the war effort.

We were effective, but not so efficient. Yet, I believe we couldn’t have accomplished what we did in support of our Soldiers, nor turned around our imbalance of effectiveness at the cost of efficiency, if not for the professional, trained civilian and military contracting cadre that got



**HILL TALK**

Antonio Baines, Hardware Branch chief, Army Office of the Legislative Liaison, and Hallock wait for the Pentagon shuttle following a meeting earlier this year with U.S. House of Representatives staffers. (Photo by Kathie Scarrah, ODASA(P))

us through the war years as a result of the decision in 1989 to create an acquisition corps.

**FROM PAST TO FUTURE**

How has Army contracting changed in the past quarter-century? Where are we headed? How we've changed is easy; where we're headed is a little more challenging.

For example, in 1989 we were just beginning to use computers in the office. That same year marked the genesis of the World Wide Web. We were slow to embrace this technology in contracting, not clearly understanding that it would drastically improve how we did business. I still recall the first computer terminal on our floor of 350 people at TACOM. We had to sign up in 15-minute increments to use it. That wasn't really a

problem back then, because most people were still using electric typewriters and were scared to death of this new technology; they could not imagine using such a thing to accomplish our mission. It may sound silly now to those raised on computers, but back then they were quite the novelty. Even when we accepted these bulky machines in our workspace, it still took some time to coordinate our "mouse reflexes" to the point where we actually saved time in whatever we were trying to accomplish.

Then, when TACOM received large numbers of computers, the frustration grew as we became the debuggers of our generation and whined about how slow they were, how often we lost our work into the Ethernet and how much faster we could accomplish our work the "old-fashioned" way. But as with anything new, it was

only a matter of time before we figured out how to make the best use of this new technology and took advantage of the tremendous capability laid before us to do more work in less time.

At the same time, we were learning how to use the new Federal Acquisition Regulation (FAR), which had first appeared in the Federal Register six years earlier. Never in my wildest imagination would I believe that years later, as the DASA(P), it would be my responsibility to ensure execution of the FAR and the Army Federal Acquisition Regulation Supplement for the entire Army contracting community!

**THE ART OF THE DEAL**

Back then, what I loved most about being a contract specialist and later a contracting officer was the art of the negotiation. A company presented its proposal with its desired price for the item to be procured. As the government representative tasked with finalizing the price to be paid, I was responsible not only to make sure that we got a fair and reasonable price, but that the Army complied with all applicable statutes and regulations, clauses and provisions in putting the contract instrument in place.

This responsibility could be mind-boggling, just as it can be today, and if we happened to be working on something that got higher-level attention or oversight, we often were called to the Pentagon to explain our decisions. Yet, I don't remember the oversight being as onerous as it is today, and I don't remember congressional interest being as acrimonious as it can be today. I attribute this to the technology explosion over the past two decades that allows instantaneous knowledge of just about everything. This knowledge allows anyone to know what is happening in time



### CELEBRATING PROFESSIONALISM

In July 2004, MG N. Ross Thompson III, military deputy to the assistant secretary of the Army for acquisition, logistics and technology and director, Army Acquisition Corps, presents the Team Excellence award to Hallock; Richard Franke, U.S. Army Tank Automotive Research, Development and Engineering Center; and Jeffrey Parsons, then-director of contracting for U.S. Army Materiel Command. TACOM contracting efforts succeeded in equipping the Iraqi armed forces and associated security forces in support of Coalition Provisional Authority initiatives. (Photo courtesy of ODASA(P))

to stop almost any contracting action in its tracks—not necessarily a bad thing in and of itself, but potentially frustrating from the standpoint of bringing actions to fruition in a timely manner and in accordance with the requirements delineated at the start of a project or program. We might ask ourselves if this is the price to be paid for technology allowing us to be timelier in bringing stakeholders into the acquisition process.

On this 25th anniversary of the Army Acquisition Corps, during more than 12 years of which our contracting efforts have been focused on contingencies in two very different and challenging theaters, we have reached a point at which we must wind down our battle rhythm, as we have before, and encourage our contracting processes to evolve. At the same time, we must figure out a way for the nearly 60 percent of our workforce

who have fewer than 10 years' experience, all earned while contracting in a contingency environment, to step back and be aware of the consequences of our actions and how they best meet the needs of our customers. By doing so, we are training the next generation to be true business advisers to our customers.

Army contracting is a fulfilling profession and one that must continue to change with the times if we are to do right by our many stakeholders. Since arriving in the National Capital Region, I have had the good fortune to meet and engage with many good and influential people who continue to strive to make a difference each and every day. I plan to be one of them. I believe we owe it to the entire acquisition workforce to engage with those around us and help each other succeed as we go about our business of meeting the nation's needs as contracting

professionals. If we're going to get it right, it's up to us to be a part of the solution. Our community needs us.

---

*MR. HARRY P. HALLOCK was appointed the DASA(P) in July 2013. He manages the development and dissemination of policies, processes and contracting business systems; directs the evaluation, measurement and continuous improvement actions for Army contracting offices worldwide, which execute contracts for major weapon systems, base logistics support, construction and wartime operational contracting in Iraq and Afghanistan; and ensures the execution of federal, DOD and Army regulations for acquisition, procurement and related business practices. As the functional career representative for contracting, the DASA(P) oversees the recruitment, training, certification and professional development of the Army's contracting workforce. Hallock was recruited into Army contracting in Warren, MI, and stayed in Warren through various positions at the TACOM Life Cycle Management Command before becoming a member of the Senior Service and the executive director of Army Contracting Command – Warren in 2007. Hallock earned an M.S. in program management from the Naval Postgraduate School in addition to his B.S. in business administration from the University of Delaware. He also completed the LOGTECH Executive Course and the Federal Executive Institute's Army Senior Leadership Development Program. Hallock is Level III certified in life-cycle logistics, program management and contracting, and Level II certified in test and evaluation engineering. He is a member of the Army Acquisition Corps and an early member of the Acquisition of the Future movement; in that capacity, he is already thinking ahead to the next 25 to 30 years and a future AL&T magazine article on what a half-century in the acquisition workforce might look like.*



# CHANGING MISSION, Challenging Climate

Looking back on 37 years of contracting

*by Mr. J.R. Richardson*

Looking back over my 37 years of working for the Army, I am astounded at the major changes that have occurred in the contracting mission area. Among the biggest changes I have seen: exponential growth of our workload from roughly 69,000 actions and \$16 billion obligated in FY79 to a high of more than 520,000 actions and \$169 billion obligated in FY08; growth of the contracting workforce and the infusion of military personnel into the acquisition workforce; regulatory growth; the increasing complexity of contracting; and the rise in the number of audits and their impact on our ability to improve in our mission area. I have also seen the mammoth effects of the Gansler Commission report, the Base Realignment and Closure Act, and the constant pendulum swing of the political climate regarding how we conduct our business of contracting for the Army.

When I began my career as a student in the Student Career Experience Program and later a contracting intern in the Mobile, AL, District of the U.S. Army Corps of Engineers in 1978, most people began and ended their federal careers in the same office. The joke among students and interns was that the only way to get promoted was to wait until enough people retired or (heaven forbid) died. While that culture had its share of problems, it wasn't without benefits. One benefit was that roles and responsibilities were very well-defined and understood. Everyone seemed to know the cradle-to-grave contracting process, and everyone was clear on their role in it. Unfortunately, most



of the roles, responsibilities and processes were not documented; they were just “known.” And those who had been doing it for so many years made it look easy. There was very little hiring going on in contracting.

Most Army leaders in the late 1990s did not understand that a looming exodus of baby boomers was fast approaching, and they were unprepared for the change that the emerging Defense Acquisition Workforce Improvement Act (DAWIA) and new Career Program 14 (CP-14) brought. There were not enough DAWIA-trained and -certified contracting professionals prepared to replace those who would soon retire. But the work was done satisfactorily, customers had few complaints, and contracts were awarded on time. It was difficult to make leaders understand the coming staffing crisis in the acquisition workforce.

### BRAIN DRAIN

To compound this impending problem, the requiring activities were also facing the exodus of their own seasoned workforce. And as the acquisition teams and contracting workforce began to shrink in the late 1990s, timelines for procurements began to increase. Major milestones began to slip. Much-needed products and services were not delivered as required. Army readiness was starting to be affected.

This predicament gave rise to an increase in the number of bridge contracts awarded as well as an increase in sole-source contracting. In the early 2000s, the GAO published a series of reports that quantified the need for a bigger contracting workforce in the Army. The DOD Acquisition 2005 Task Force Final Report entitled “Shaping the Civilian Acquisition Workforce of the Future” stated bluntly that DOD “is facing a crisis



### COMPLEX PROCESSES

SFC Ricardo Bailey of the 928th Contingency Contracting Battalion, 409th Contracting Support Brigade, and TSgt Jonathon Hollis of U.S. Air Forces in Europe Headquarters, both contingency contracting officers, discuss the acquisition process for chaplain services in support of the multimodal mission at Mihail Kogalniceanu Air Base, Romania, Jan. 30. As contracts have grown more complex, so have the regulations, policy and guidance related to the contracting process. (Photo by SSG Warren W. Wright Jr., 21st Theater Sustainment Command Public Affairs)

### MORE HANDS NEEDED

Programs like ACC’s Deployable Cadre point out the increasing need for deployable civilians as the expeditionary mission grows. (Image courtesy of ACC)



**FUELING THE FUTURE**

SGT Christina Dafney-Pressley, contracting officer’s representative for KBR fueling operations, talks with a fueler March 20 at Camp Bondsteel, Kosovo. Dafney-Pressley, the NCO-in-charge of the fuel point, is responsible for more than \$500,000 worth of fuel on a weekly basis. Contract vehicles have become much more complex over the last 30 years. Regulations, policy and guidance have also increased considerably. (Photo by CPT Kevin Sandell, 11th Public Affairs Detachment)

that can dramatically affect our Nation’s ability to provide warfighters with modern weapon systems needed to defend our national interests. After 11 consecutive years of downsizing, we face serious imbalances in the skills and experience of our highly talented and specialized civilian workforce. Further, 50 percent will be eligible to retire by 2005. In some occupations, half of the current employees will be gone by 2006.”

Army leaders at all levels, including the U.S. Army Materiel Command (AMC), the deputy assistant secretary of the Army for procurement and the U.S. Army Contracting Agency, finally realized it was time to do something, and quickly. The National Defense Authorization Act for Fiscal Year 2008 directed the establishment of the Defense Acquisition Workforce Development Fund (DAWDF), which enabled DOD to recruit, hire, develop, train, recognize and retain its acquisition workforce.

One year later, the secretary of defense announced an initiative to grow the defense acquisition workforce by 20,000 positions by FY15. The Army’s goal with regard to this initiative was to in-source more than 3,200 positions and hire 1,885 new government acquisition civilian personnel. The DAWDF became the funding mechanism to “prime the pump” with regard to the new-hire initiative. An Army Acquisition Workforce Growth Task Force was established in January 2010 to capture specific organizational input with regard to the new hires.

Thus began the Army’s massive hiring campaign for new interns into the CP-14 contracting workforce. Whereas once even the best and brightest were lucky to be promoted to a GS-1102-12 contracting officer after about 20 years in contracting, many employees hired

at the GS-7 level were promoted to the GS-12 level with limited experience, and they were required to handle some of our most complex contracts. Within the course of five years with the Army, a new employee could expect to be promoted to a GS-1102-13 in a team leader and contracting officer role, because of the personnel shortages.

### WARTIME CONTRACTING

Hiring and training new staff solved the staffing problem while creating another: With too few seasoned contracting officers to lead and mentor new hires, the quality of contracts began to decline. Newly awarded contracts were often simply copied and pasted from one that had been awarded previously. Additionally, the operations tempo sharply increased as the Army entered the wars in Iraq and Afghanistan. As major defense contractors came to the table to negotiate contracts for complex, critical requirements in support of these wars, the government team often consisted of inexperienced, risk-averse personnel. This resulted in frustration among our industry partners as contracting officers became slow to communicate, adding to the time it took to get things done.

Contract vehicles have become hugely more complex over the last 30 years, from my perspective. When I began my contracting career, we awarded mainly lowest-price, technically acceptable (LPTA), firm-fixed-price contracts. There were very few negotiated contracts or cost-type contracts awarded under Federal Acquisition Regulation (FAR) Part 15. In fact, contracting officers had to request permission to use a “best value” negotiation, because it was a rare contract type and not well understood. Under FAR Part 15, the government can pay more for better quality, using trade-offs with other criteria when evaluating proposals. (Later,

best value became the contract vehicle of choice for a number of years, in spite of its complexity.)

But once again, the rules changed, requiring contracting officers to request special permission if they were not planning to negotiate their contracts. As the years passed, the best-value approach came under criticism. Trends indicated that most best-value source selections resulted in awards to the lowest offeror in the competitive range. Therefore, it did not make sense to spend the time and resources required to award contracts using this approach. Again, I saw the pendulum swing back, and the preferred method of contracting again became LPTA. This did not please industry or the requirements community, and they pushed to return to the FAR Part 15 trade-off process.

### OVERSIGHT AND REORGANIZATION

The Gansler Commission, chaired by former Undersecretary of Defense for Acquisition, Technology and Logistics Dr. Jacques S. Gansler, issued its report on Oct. 31, 2007. The report indicated that contracting needed greater oversight. Contracting could no longer be performed in small offices at every command and location, the report stated, but should be consolidated and aligned under the leadership of general officers. The Army established the contracting 51C military occupational specialty, formed new contracting agencies and gave general officers throughout the Army responsibility for overseeing contracting.

In the years that followed, the Army formed and reorganized many commands, establishing the U.S. Army Contracting Agency and U.S. Army Contracting Command (ACC). MG Camille M. Nichols became the first general to command

the ACC. Subordinate commands for expeditionary contracting and mission and installation contracting—the U.S. Army Expeditionary Contracting Command, and the U.S. Army Mission and Installation Contracting Command, respectively—followed. However, organizing and reorganizing contracting over the years, while a strategically correct approach, resulted in more instability and confusion among the workforce, customers and industry.

Things are improving, but we continue to struggle with this instability and the question of how best to organize the Army’s contracting operations. Contracting in support of the major weapon systems at the program executive offices and life-cycle management commands has been consolidated at ACC contracting centers. Now, instead of multiple heads of contracting activity (HCAs) in ACC, the single HCA for ACC has been consolidated at the four-star level, with GEN Dennis L. Via, AMC commanding general, serving as the first HCA for all of AMC, including ACC. The Army is currently conducting a transformation study to determine how best to organize the contracting function.

### CLIMATE OF CONCERN

With the growth in the contracting workload and the proliferation of organizations handling it came a massive increase in regulation, policy and guidance over the last three decades. It is difficult to follow all the rules when so many different offices and sources are issuing new directives, and difficult for a contract specialist or contracting officer to ensure everything has been incorporated into the contract.

The number of audit agencies and audits in contracting has also exponentially increased over the years. Between FY06

**WITH THE GROWTH  
IN THE CONTRACTING  
WORKLOAD AND  
THE PROLIFERATION  
OF ORGANIZATIONS  
HANDLING IT CAME A  
MASSIVE INCREASE IN  
REGULATION, POLICY  
AND GUIDANCE OVER  
THE LAST THREE  
DECADES.**

and FY11, more than 5,200 audits and inspections of Army contracting offices were conducted. Audits have created a climate of concern among young practitioners, making them very conservative in their approach to contracting. Another unintended consequence of too many audits is that they tend to divert the focus of the staff to audit findings and corrective action plans, leaving less time and fewer resources to execute the current workload. This tends to have the opposite effect than the audits intended.

While the Army's Office of Business Transformation has made great strides to improve the organizational effectiveness and efficiency of many Army commands, there are still many opportunities for improvement in the contracting community. LTG Thomas W. Spoehr, director, Army Office of Business Transformation, summed it up in his article, "Change in Order to Stay 'Army Strong,'" in the April 2014 issue of the U.S. Army Combined Arms Center's Military Review, arguing that changing the culture to better value the efficient use of resources is critical to our survival. "We have the best

Army in the world, but continued success is not assured. We must transform the way we operate in order to remain Army Strong," Spoehr wrote.

To that end, my last effort as I wrap up my 37-year career in Army contracting is to bring a culture of continuous process improvement (CPI) to Army contracting. It starts with documenting our processes. Using a Lean Six Sigma (LSS) approach to contracting, we can deliver outstanding service to our requiring activities, turning our customers into raving fans. Communicating what we do and how we do it is critical to our ability to deliver much-needed supplies and services to our Army.

It seems that our contracting community spends more time dealing with problems, performing re-work and putting out the fires we start, than investing the time and energy in CPI. We must consolidate the many scattered initiatives, aiming to improve contracting processes under the CPI umbrella so that the resulting changes can become part of our culture without continually reinventing the wheel. Fundamentally, CPI is about spending resources proactively instead of reactively. But there is so much more to CPI than training or completing LSS projects: also important are getting stakeholder buy-in up front, considering the voice of our customers, preparing the leadership to be champions of change and rolling out great products in a way that ensures that new processes and procedures are understood, anticipated and embraced.

#### CONCLUSION

Over my three-plus decades in Army contracting, I've seen many changes, and the time for another big change is at hand. We must change our culture now no matter how difficult—the risk is too

great not to. In the current climate of personnel shortages and budget cuts, we must dedicate our precious resources to standardizing and documenting our processes, defining roles and responsibilities, and becoming proactive rather than reactive. This is the only way to be a more efficient organization. I wholeheartedly echo the words of LTG Spoehr: "If we are unable to change the way we operate, then we fundamentally risk our Soldiers' lives by sending them to conflict unprepared due to a lack of basic resources to properly train and equip them."

Budget cuts are driving a big change. A study of Army contracting organizational alignment is underway at the request of the secretary of the Army. A bill currently before Congress mandates CPI. Consolidating a single HCA under GEN Via is driving standardization. These three things will serve as great conduits for change. The contracting workforce of today is very dynamic and accustomed to rapid implementation of change, whether in organizational structure, policy or technology solutions. I am very excited about the future of Army contracting and proud to count myself among this highly skilled group of Army professionals.

*For more information about Army contracting, go to [www.us.army/acc](http://www.us.army/acc).*

---

*MR. J.R. RICHARDSON served in numerous senior Army civilian leadership positions throughout his 37-year contracting career. He was director of contracting operations at ACC from 2010 until his retirement at the end of September. He received a B.S. in business from Stillman College. He is Level III certified in contracting and is a member of the Army Acquisition Corps.*

### Distributed Common Ground System – Army:

- Enables processing, exploitation and dissemination of intelligence products.
- Fuses workstations, hardware and software, data storage and downlinks to support analysts across the globe.
- Connects our Soldiers at every echelon to the joint intelligence, surveillance and reconnaissance (ISR) enterprise.
- Integrates commercial and government capabilities.

**ENABLING** our most **POWERFUL** intelligence asset:

# The Analyst



Committed to improving DCGS-A by incorporating user feedback, increasing ease of use and embracing commercial software innovation.

Conducting routine industry day engagements to foster competition and maintain open communications.

Kicking off DCGS-A Increment 2 program competition in 2016 with a focus on commercial technologies and compliance with intelligence community information technology enterprise.



# DCGS A

PEO  
IEW&S





### CROSSING NATIONAL BOUNDARIES

Engineer and Scientist Exchange Program (ESEP) participant Steve Carrig and co-worker Julia Freeman operate the Chemical Articulated Test Manikin at the Environmental Test Facility of the Defence Science and Technology Organisation (DSTO), an office of the Australia Department of Defence, in Melbourne, Australia. Carrig participated in the Army's ESEP from July 2011 to June 2013. ESEP applicants—midcareer scientists and engineers from across the Army—can request assignment in 17 countries. (Photo by Brian Crowley, DSTO)



FROM THE DEPUTY ASSISTANT  
SECRETARY OF THE ARMY FOR PLANS  
AND RESOURCES  
MR. DALE A. ORMOND



# PULLING TOGETHER

Collaboration drives integration,  
which in turn drives the future force

**A**chieving the Army chief of staff's vision for Force 2025 and Beyond has clear implications for Army acquisition. Some aspects are obvious, such as the need for greater lethality and reduced procurements. However, there is one important aspect that might not leap immediately to mind, but that drives the consumer technology industry: eliminating the friction and loss that come from technology that is not well-integrated.

The corporations that created the defining consumer technologies of the past few decades have turned their attention over the past several years to building ecosystems. These are collections of software, hardware and services that allow us to move from computer to tablet to phone without losing access to our important information or capabilities. These companies are now extending the ecosystems to the Internet of things—thermostats, refrigerators, home security systems and more.

Apple, Google, Amazon and others have not turned away from their core products or services, as they know they can't stitch together second-rate products to create an attractive ecosystem.

But they have looked strategically at their markets, their customers and their emerging technologies and determined that consumers want to remove the friction and loss caused by not having the information they need or the capability to effectively use the information they have. In other words, consumers don't want to stop and think about syncing devices, puzzle over interfaces, or wait until they can physically relocate themselves or one of their devices.

What these companies are doing illustrates exactly the goals we have for Soldiers and their commanders, and we must deliver on our goals if we are to have a smaller force with equal or greater combat power than today's Army. Systems complexity costs Soldiers time, energy and attention on the battlefield. Poorly integrated systems delay the ability of decision-makers to act when it will do the most good, and may deny them the ability to act at all.

## A COMMERCIAL MODEL

Just as technology companies look to deliver an ecosystem that maximizes consumers' time and minimizes their loss, we must



### COMMUNITIES OF PRACTICE

The author, center, then-director of RDECOM, leads a discussion about the communities of practice during a town-hall video teleconference April 15 at Aberdeen Proving Ground, MD. RDECOM's establishment of the technology-based communities across the enterprise enables greater collaboration, technical situational awareness and integration. (Photo by Conrad Johnson, RDECOM)



### OPEN TO COLLABORATION

Scientists Dr. Kenneth Ball, left, a postdoctoral researcher at the University of Texas at San Antonio; Stephen Gordon of DCS Corp.; and ARL statistician Vernon Lawhern gather in an ARL lab to discuss new results of a recent neuroscientific analysis. Their collaboration exemplifies ARL's recently launched Open Campus initiative, which aims to foster industry and academia's collaboration with Army scientists and engineers in areas of common interest. (Photo courtesy of ARL Public Affairs)

deliver integrated capabilities that maximize opportunity and minimize risk.

The U.S. Army Materiel Command's Research, Development and Engineering Command (RDECOM) works to deliver integrated solutions by leveraging the expertise of scientists and engineers from across its seven centers and laboratories. One example is the Soldier Wearable Integrated Power System (SWIPES), which brings together the command's Communications-Electronics Research, Development and Engineering Center (CERDEC) and Natick Soldier Research, Development and Engineering Center (NSRDEC).

SWIPES uses the Modular Lightweight Load-Carrying Equipment vest to integrate force protection, electronics and communications equipment with advanced power sources. The system supplies a lightweight main battery from a central location in the vest to power all end items, and places pouch-mounted chargers and power cables for batteries, GPS units, shot-detection systems and handheld communications into the vest. SWIPES allows for extended mission times without the need to swap out batteries or power sources, by keeping devices charged at all times.

That kind of collaboration is of necessity greater than that of the corporations who are supplying our phones and cloud computing services, because the government has a wider array of interests than a corporation, such as maintaining the domestic industrial base, ensuring equal opportunity, encouraging small business, etc. Our goals are more important, too: securing the nation and bringing Soldiers home safe.

RDECOM plays a unique role in the acquisition community, meaning that



its efforts have implications for a large part of the acquisition workforce as well as for the Soldier and the battle formation commander. RDECOM employees matrixed to organizations across the Army, DOD and other federal agencies provided more than 9,600 reimbursable manpower work-years in FY13. Its biggest customers were the program executive offices, which contracted for almost 5,500 manpower years of support. Life-cycle management commands were its next biggest customers, contracting for more than 1,600 manpower years. Other Army organizations accounted for more than 500 manpower years of the total.

RDECOM just published its new strategic plan, “Enabling Battlefield Dominance Through Technology, FY 2015 – FY 2040.” As it begins to implement this plan, it does so with the understanding that its many partners across the acquisition community will benefit from its enterprise efficiencies and from the capabilities it gives to its employees embedded within their organizations. The Army will benefit because the organization that is perhaps integrated into more parts of the acquisition community than any other will be focusing on collaboration and integration.

## COLLABORATION CAPABILITIES

This year, RDECOM launched a new collaboration policy within the command and developed communities of practice to spark innovation and drive collaboration within specific technology areas, such as cyber, long-range precision fires, aircraft survivability, etc. The command’s efforts to stimulate and foster collaboration include:

- **Open Campus:** The U.S. Army Research Laboratory (ARL) launched



### FAST FIELDWORK

Nigerian Army Public Affairs Sgt. Mohammad Gongkie, left, talks with MAJ Brent Odom, RDECOM Field Assistance in Science and Technology (FAST) Adviser to U.S. Army Africa, March 16 in Cameroon during Central Accord 14. FAST advisers develop and strengthen military-to-military ties with current and potential allies. (U.S. Army photo)

this initiative in May to foster industry and academia collaboration with Army scientists and engineers in areas of common interest. The academic community and industry benefit from this arrangement by collaborating with ARL’s research staff at its unique research facilities, while the Army benefits from bringing together a larger pool of innovative talent than was previously possible.

- **Systems engineering:** Since last year, RDECOM has trained more than 385 professionals in the Systems Engineering Advanced Course to develop and refine their skills in analyzing systems, synthesizing holistic solutions, and
- **Virtual laboratory:** To improve integration across all aspects of research, development and engineering, RDECOM is building a virtual laboratory that will allow project managers, within the next few years, to

making sound judgments in the presence of ambiguity, rapid change and nontechnical constraints. It also developed the Systems Engineering Process Asset Library this year as a central resource that will allow the command’s growing number of systems engineers to use an integrated set of services, processes, tools, training and artifacts. This efficiency will improve service to RDECOM’s stakeholders.

search for and consult with scientists and engineers across the enterprise who have specific skills or experience needed to make a project successful.

- **Communities of practice:** Technologies increasingly cross legacy commodity barriers. Cybersecurity is no longer just the domain of communications and computers, for example, but is vital to a wide variety of systems that rely on computational power for navigation, targeting, robotic systems and more. RDECOM has established technology-based communities of practice across the enterprise that mirror the Army's portfolio structure. CERDEC leads the effort, but everyone with a stake in cybersecurity—defense or offense—is part of the community and can influence the technology to make sure our research efforts meet the Army's needs.
- **Project-based approach:** In this way, the command brings the expertise and experience of multiple organizations to bear on specific needs. For example, five of the command's six centers have joined to develop the Modular Active Protection Systems (MAPS), a survivability solution for ground vehicles that will address the next generation of emerging threats. Advanced threats currently require armor solutions that push vehicles beyond a practical weight. MAPS enhances survivability against advanced threats without adding significant weight to ground vehicles, in one of two ways: a soft-kill defeat mechanism that targets the incoming round's guidance system or a hard-kill defeat mechanism that physically disrupts the threat before it hits the vehicle. The outcome is the same: keeping the vehicle occupants safe. The technology also supports leaner brigade combat teams. Leading this enterprise-wide effort is the Tank Automotive

Research, Development and Engineering Center, with engineering and technical input from the Aviation and Missile Research, Development and Engineering Center, Armament Research, Development and Engineering Center, CERDEC and ARL.

- **External engagement and support:** RDECOM has worldwide representation through its civilian scientists, engineers and military uniformed scientists. Through the efforts of the RDECs and ARL, RDECOM completed two of eight Defense Acquisition Challenge (DAC) Program starts, with six scheduled to close in FY14. DAC, which was created in 2003 to integrate mature technologies into the acquisition cycle, allows U.S. vendors to submit proposals for evaluation by the Army. RDECOM also completed seven Foreign Comparative Testing (FCT) Program initiatives, with a mission to find and evaluate solutions to meet the Army's operational needs, regardless of the origin of that technology. FCT funds the testing of foreign non-developmental items, commercial off-the-shelf items or those items in a late stage of development that demonstrate potential. The command also recently deployed 10 new participants and has 22 applicants for the FY14 Engineer and Scientist Exchange Program, which allows midcareer scientists and engineers from across the Army an opportunity for temporary assignment with an allied government.
- **Field Assistance in Science and Technology:** RDECOM science advisers continue to develop and strengthen military-to-military ties with current and potential allies. They are also on the staffs of some of the Army's largest commands so that they can help the commands better understand our

Soldiers' needs. They participate in exercises and deploy to the battlefield. This is a crucial step in understanding what Soldiers and commanders need, which is what drives smart integration.

## CONCLUSION

This is more than a list of programs and partnerships; it shows that RDECOM is at the nexus of a global science and technology network. In the past, it may have been enough to use RDECOM's expertise and partners to deliver new technologies. To achieve the chief of staff's vision, however, the enterprise must deliver a new level of integration to free the Soldier from the burdens of poorly integrated systems.

To do that, it must achieve a new level of collaboration. With thousands of engineers embedded with its acquisition partners and thousands of partnerships and agreements, RDECOM is the natural choice to lead this collaboration on integrating technologies, thus allowing a smaller Army to spend its time defending the nation's interests instead of pushing information from one disconnected system to another.

*For more information, go to [www.army.mill/rdecom](http://www.army.mill/rdecom).*

---

*MR. DALE A. ORMOND is the deputy assistant secretary of the Army for plans and resources in the Office of the Assistant Secretary of the Army for Manpower and Reserve Affairs. Until recently, he was director of RDECOM. He holds an M.S. in environmental systems engineering from Clemson University and is a 1985 graduate of the U.S. Naval Academy. He is Level III certified in acquisition program management. He was selected for the Senior Executive Service in July 2004.*

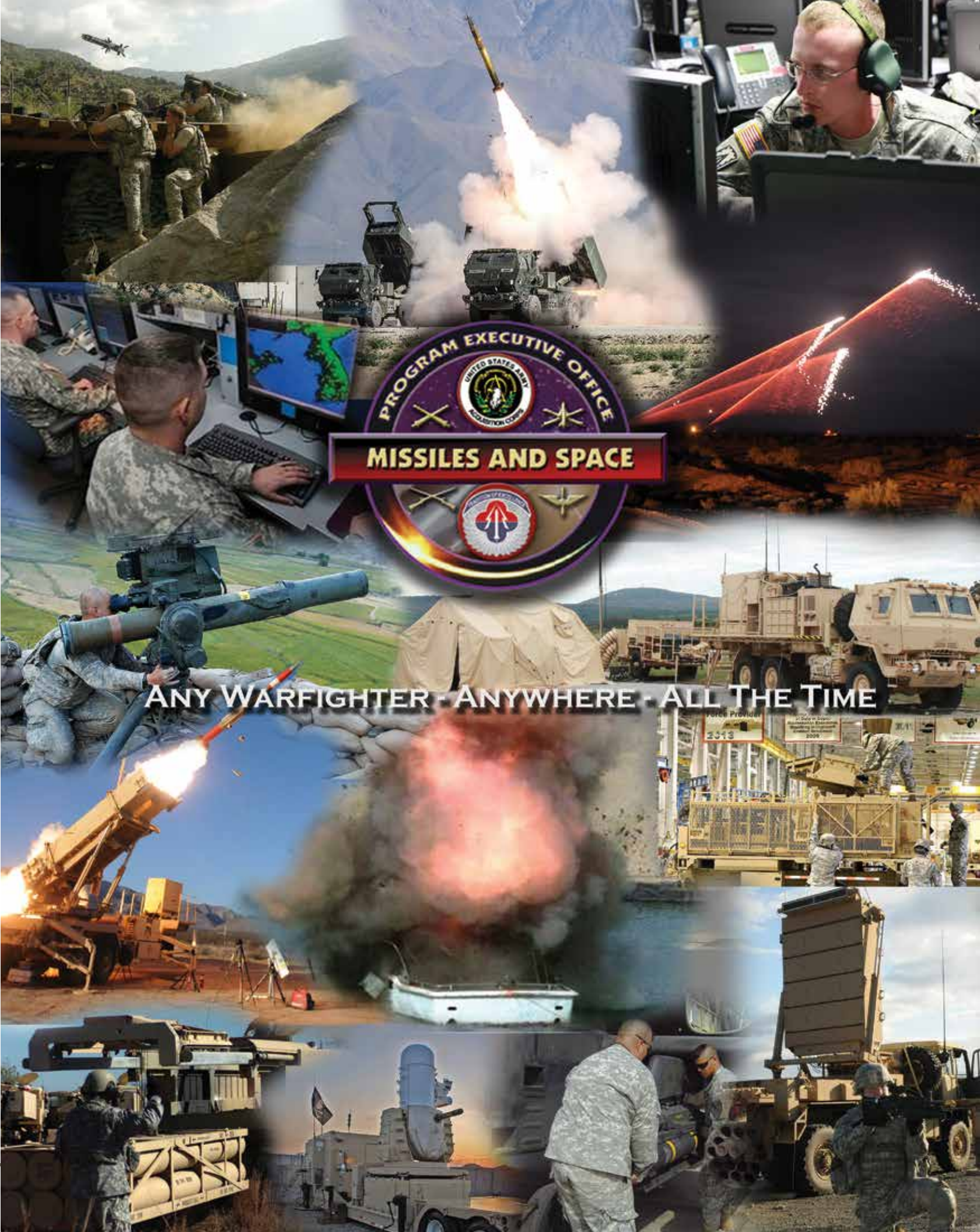

PROGRAM EXECUTIVE OFFICE  
MISSILES AND SPACE

ANY WARFIGHTER - ANYWHERE - ALL THE TIME



OUTSIDE THE BOX

THINKING

INSIDE THE BOX

How a shipping container became  
a weapon system

*by Ms. Cherie Blocker*

**F**or those who support our Soldiers, nothing is more important than ensuring that they have the safest, most reliable equipment and training available. No one wants a Soldier in battle to be vulnerable to the enemy or to the elements. From sophisticated communications technology to the latest in protective gear, safety and survivability are top priorities.

But getting Soldiers gear and equipment that meets their needs and addresses their challenges can be difficult. The lengthy acquisition process, lack of funding and competition among priorities can hamper the timely deployment of even the best products. However, one Army engineer was determined to address a critical need and get a simple but effective concept—the Containerized Weapon System (CWS)—into the field.

CWS is a rapidly deployable, self-contained weapon system that Soldiers can easily integrate with surveillance and reconnaissance assets that detect, assess and warn the warfighter of threats to any base. The business end of CWS is a CROWS—the Common Remotely Operated Weapon Station. CWS' CROWS is equipped with day and night cameras, a laser rangefinder and a variety of weapons with a 360-degree field of fire. The mast of the CWS



can elevate the CROWS unit up to 15 feet, which allows the gunner to use its slew-to-cue capability—that is, the ability to slew to any cursor-on-target target selected by the gunner.

Spearheading the development of CWS was John Dillon, an electronics engineer at the Weapons Development and Integration Directorate of the U.S. Army Aviation and Missile Research, Development and Engineering Center (AMRDEC). In developing the system, Dillon, a 33-year government employee assigned to the Close Combat Weapon Systems (CCWS) Project Office, was trying to provide Soldiers with a new solution to an age-old problem while efficiently using proven Army combat systems. The problem: Shrinking DOD budgets demand that more and more be done with existing systems to maximize their life span, “which means we have to learn how to adapt our current systems in new and creative ways,” Dillon said.

## A PLATFORM FOR PROTECTION

Dillon had worked extensively on the Javelin missile program and knew that the portable, shoulder-fired, medium-range weapon could bring increased lethality to both mobile and fixed-base platforms. He and his AMRDEC team began to develop a means to integrate it onto vehicle platforms and specifically the CROWS platform.

Their concept was simple enough: modify a standard 20-foot shipping container to become a protective device for Soldiers in remote areas or on the front lines. They demonstrated this new concept to user communities and garnered great interest for further development, but budget restrictions hampered their progress.

In 2009, Dillon began to discuss his idea



### ‘ONE NASTY JACK-IN-THE-BOX’

In Afghanistan, CWS gives Soldiers in forward areas a new capability to combat indirect fire and to cover troops on patrol. Word of its potential spread quickly at a time when Soldiers were looking for new ways to defeat insurgents. (Photos courtesy of Jay Crawford, CCWS Project Office)

with Rapid Response Concepts (RRC), a company focused on delivering remote site infrastructure solutions in a variety of settings. Rather than a moving vehicle, which wasn’t always needed, they envisioned a secure yet portable space that would protect the Soldier and be capable of mounting existing weapon systems like Javelin or CROWS, thus expanding their use in the field and making better use of resources. AMRDEC and RRC entered into a cooperative research and development agreement that year to build the system.

Sometimes used as an armored bunk room, the venerable shipping container was a good fit for the Army and for other services, Dillon said. It’s more solid than a tent and easily modified to mount weapons like the Javelin and CROWS. Commercial applications were

also feasible; shipping companies could potentially use the system to defend against increasingly common attacks by pirate groups off the coast of Africa and across the Middle East.

### BUILDING THE BOX

The group presented its concept to the Rapid Equipping Force (REF), which works to harness current and emerging technologies to provide rapid solutions to urgently required capabilities. REF was interested because the proposed solution incorporated technology from previous projects as well as current inventory, thus maximizing resources while reducing cost, training requirements and the logistics tail. But REF expressed concern that it might be too big and instead suggested using a smaller container and moving the operators to another, protected location.



**ON THE SCENE**

Test engineer Jay Crawford of the CCWS Project Office travels in a convoy in September 2013 to the OP at the FOB known as Rocket City, so named because it took so much mortar and rocket indirect fire. Within three days of installing the CWS, a rocket was launched over the OP into the main base. The CWS operator located the rocket's point of origin and engaged it with the CWS within seconds, stopping incoming fire from that sector for more than a month.

However, that solution presented a new challenge: The existing eight-meter data cables were not long enough to provide the operator sufficient distance from the container while still controlling the system. The team struggled with this issue, which was resolved two years later. In order to achieve the stand-off without a degradation in signal, CWS needed fiber-optic cable, which also meant that CROWS signals had to be converted from copper to fiber-optic, and achieving that required the development of two transceiver boxes, one for the container end and one for the operator's end. And development meant testing for safety as well as environmental extremes to make sure the system would perform in all environments and not pose a safety hazard to the Soldier. That Standoff Extension Kit was developed by Kongsberg Protech Systems, which also makes the CROWS. With this new equipment, AMRDEC and RRC finalized the smaller container design.



**PRIME LOCATION**

Test engineer Jay Crawford of the CCWS Project Office checks out a location in Afghanistan in September 2013 that ultimately became a CWS site. Crawford was instrumental in setting up the new system at two sites in theater. He checked the system's performance under different conditions, took delivery of parts, conducted maintenance and trained the Soldiers in the proper use and potential of the CWS.

**10-LINER NETS 10 UNITS**

To get a capability to the field, the requesting unit must submit a requirement, known at REF as a "10-liner." For the CWS, the 10-liner required the weapon to be placed on the perimeter and the operator located up to one kilometer away in the operations center, keeping Soldiers operating the weapon at a safe distance. Word of the project began to spread from the CWS demonstrations, at a time when insurgents in Afghanistan were challenging coalition troops with vehicle-borne improvised explosive devices, and more 10-liners began to roll in from units in theater. As a result, REF agreed to fund the cost of 10 units.

But there was one more component needed: the computerized system that would communicate with other sensors to send real-time target data to the



weapons and provide the operator with environmental information. AMRDEC worked with Invariant Corp. to develop customized software that would manage the system, and RRC contacted HDT Global to refine the power management resources that would keep the container operational.

### IS IT READY YET?

Next up, testing. The U.S. Army Test and Evaluation Command (ATEC) tested the modified shipping container outfitted with the operational technology the Soldier needed, at Fort Huachuca, AZ, in early 2013. ATEC supported the quick turnaround needed for the system and worked diligently to confirm its safe operation by mid-June.

CCWS teamed with REF, AMRDEC and the project manager for Soldier weapons within the Program Executive Office for Soldier to develop an accelerated program plan. The partnership allowed each organization to harness its strengths to get CWS into theater quickly. REF described the partnership as “the perfect marriage.” The first CWS hit the ground in Afghanistan eight months after receipt of funding.

Jay Crawford, an experienced test engineer from the CCWS Project Office, was working in Afghanistan when he saw the 10-liner come through for the CWS. He and Dillon have worked together for 20 years on various projects, including the Javelin missile.

Complications arose with getting the first unit into theater because of logistical issues with transport and field support, in addition to the normal requirements for briefs to various levels of leadership involved in theater. Crawford stepped in. He volunteered to provide hands-on expertise to get this new equipment into

field use. He set up the new system in two different locations and checked its performance under different conditions. He took delivery of parts, conducted necessary maintenance and, most important, trained the Soldiers in its proper use and showed them the system’s potential in order to maximize the investment in its development.

“My greatest satisfaction is seeing something I’ve worked on used to help the warfighter,” Crawford said. “I’ve often told folks that I have the best job in the world. I get to go to the field [and] test new equipment to make sure it will work when the warfighter needs it.”

### FIRST STOP: ROCKET CITY

The first two CWS units were put in place at a forward operating base (FOB) nicknamed Rocket City because it took so much mortar and rocket indirect fire (IDF). The FOB’s first sergeant had built a small outpost (OP) to push the enemy away and reduce their effectiveness. He saw that CWS could reduce the risk to guards on duty. Within three days of installing the CWS, a rocket was launched over the OP into the main base. The CWS operator located the rocket’s point of origin and engaged it with the CWS within seconds, stopping incoming fire from that sector for more than a month.

CWS was also used at this location to cover troops on patrol. In the past, snipers covered the patrols. “If we take contact, we just take cover and let the CWS go to work,” the first sergeant reported.

### CONCLUSION

Initial feedback from the field was extremely positive. One first sergeant submitted this comment: “... Just wanted to give you a quick update on the CWS. It has continued to be a force multiplier. Today we received one round of IDF

from outside the OP and were able to engage the enemy with the CWS. I knew that it would only take days before the CWS would prove to be a huge asset to have on the OP. I, along with my unit, can’t thank you and everyone that has been a part of this project [enough]. You all have truly made us a more lethal and safer force ...”

CCWS Project Manager Bill Ruta noted that CWS “keeps the Soldier foremost in mind.” While the system is still in the assessment phase, additional CWS units are ready for deployment. Larger solar panels have been added for greater power, among other improvements.

Based on the favorable reception CWS has received so far in Afghanistan, Dillon and his colleagues hope to get permanent funding so that CWS can become a program of record. Requests are rolling in from many units and are waiting to be filled. In the meantime, Dillon couldn’t be happier with how the project went. “I don’t think there’s any greater feeling than when you hear back from Soldiers in the field about how the systems or projects that you have been working on have saved lives and have enabled them to come home to their families. It really motivates you to say to yourself, ‘How can we do more for them?’ They really deserve our best in all we do.”

*For more information about CCWS PO, go to <http://www.msl.army.mil/Pages/CCWS/default.html>.*

*MS. CHERIE BLOCKER is a knowledge management specialist at the CCWS Project Office. She serves as the integrated digital environment lead. She is Level II certified in information technology.*



# ARMY ACQUISITION: A BRIEF HISTORY

Legislation, scandal, regulation, reform

*by Mr. Steve Stark and Ms. Susan L. Follett*

**T**he U.S. Army has been procuring goods and services from the private sector since long before there was a United States. Individual handcrafted rifles and pistols, food and clothing, gunpowder and lead were some of the not particularly sophisticated needs of the nascent republic's Army.

But acquisition today is more than procurement, and today the Army's needs are very sophisticated indeed. The Hon. Heidi Shyu, the Army acquisition executive, is also the assistant secretary of the Army for acquisition, logistics and technology, and nowadays "acquisition" is an umbrella term that indicates not only procurement, logistics, and science and technology, but also research and development, contracting, sustainment, maintenance—and anything else in the cradle-to-grave life cycle of defense materiel and services. The general umbrella of acquisition may encompass more subspecialties than any other field in DOD.

The story of acquisition as we know it today is also a parallel history of legislation and regulation begat of investigations and presidential commissions—in particular the Packard Commission, also known as the President's Blue Ribbon Commission

on Defense Management, in 1986—and in reaction to procurement-related scandals. The Packard Commission, chaired by David Packard, co-founder of Hewlett-Packard Co. and the deputy secretary of defense from 1969 to 1971, came about as a result of headline-grabbing cost anomalies during the military buildup in the first term of President Ronald Reagan, such as \$600 hammers and \$700 toilet seats.

The Packard Commission's report was followed by the Defense Reorganization Act of 1986, which created an acquisition executive for each service. Until the report and the ensuing legislation, the concept of a professional "acquisition workforce" as we know it today did not exist. The commission's report resulted in, among other things, the creation of the undersecretary of defense for acquisition as well as the acquisition executive positions. It also led to the Defense Acquisition Workforce Improvement Act in 1990, the creation of the Defense Acquisition University in 1991, and a host of other reforms that are part of the way Army acquisition does business today.

In 1989, GEN Carl E. Vuono, then chief of staff of the Army and previously the commanding general of the U.S. Army Training and Doctrine Command, authorized the establishment of





# THE FIRST 25 YEARS

As is often the case, the history of the Army Acquisition Corps (AAC) doesn't begin with its actual founding. Rather, it begins in the recommendations of the Packard Commission and the Goldwater-Nichols Defense Reorganization Act of 1986. As a result of that legislation, the Army adopted a three-tiered acquisition management chain in 1987 that consisted of the Army acquisition executive, program executive officers (PEOs) and project or product managers. PEOs were given responsibility for cost and performance of specific acquisition programs, and project and product managers in turn reported to their respective PEOs. Twenty PEOs were established on May 1, 1987. GEN Carl E. Vuono signed the memo that would create the AAC in 1989. The Defense Workforce Improvement Act followed in 1990, and Defense Acquisition University followed quickly in 1991.

This timeline of the first 25 years combines input from the PEOs with Army AL&T magazine staff research. It is not intended to be exhaustive, but to provide a general overview of how far the AAC and the Army Acquisition, Logistics and Technology Workforce have come in 2 1/2 decades.



- ### ACRONYMS
- **AAMTI:** AMEDD Advanced Medical Technology Initiative
  - **ACAT:** Acquisition Category
  - **ACMO:** Army Career Management Office
  - **ACWA:** Assembled Chemical Weapons Alternatives
  - **AHIP:** Army Helicopter Improvement Program
  - **ALS:** Analytical Laboratory System
  - **AMC:** Army Materiel Command
  - **AME PO:** Aviation Mission Equipment Project Office
  - **AMEDD:** Army Medical Department
  - **AMD:** Air and Missile Defense
  - **AMMO:** Ammunition
  - **AMRDEC:** Aviation and Missile Research, Development and Engineering Center
  - **AMSAA:** Army Materiel Systems Analysis Activity
  - **Army SSC:** Army Soldier Systems Center
  - **C3T:** Command, Control and Communications – Tactical
  - **CAB:** Combat Aviation Brigade
  - **CASUP:** Cockpit and Sensor Upgrade Program
  - **COMETS:** Combat Medic Training System
  - **CREW:** Counter-Radio Controlled IED Electronic Warfare
  - **CROWS:** Common Remotely Operated Weapon Station
  - **CS&CSS:** Combat Support and Combat Service Support
  - **CST:** Civil Support Team
  - **CT2:** Commercialization/Technology Transfer
  - **CWA:** chemical weapons agent
  - **DAWIA:** Defense Acquisition Workforce Improvement Act
  - **ECTD:** Electronic Common Technical Document
  - **EIS:** Enterprise Information Systems
  - **ENVG:** Enhanced Night Vision Goggle, AN/PSQ-20
  - **FAS:** Field Artillery Systems
  - **FBCB2:** Force XXI Battle Command Brigade and Below
  - **FIOTV:** Female Improved Outer Tactical Vest
  - **GCS:** Ground Combat Systems
  - **GFEBs:** General Fund Enterprise Business Systems
  - **GPALS:** Global Protection Against Limited Strikes
  - **HETS:** Heavy Equipment Transporter System
  - **HMMWV:** High Mobility Multipurpose Wheeled Vehicle
  - **IED:** Improvised explosive device
  - **IEW&S:** Intelligence, Electronic Warfare and Sensors
  - **JBAIDS:** Joint Biological Agent Identification and Diagnostic System
  - **JMC:** Joint Munitions Command
  - **JPEO CBD:** Joint Program Executive Office for Chemical and Biological Defense
  - **LUH:** Light Use Helicopter
  - **MPLH:** Multipurpose Lightweight Helicopter
  - **MRAP:** Mine Resistant Ambush Protected vehicle
  - **OIF:** Operation Iraqi Freedom
  - **PdM AGSE:** Product Manager for Aviation Ground Support Equipment
  - **RFI:** Rapid Fielding Initiative
  - **SAP:** Systems Application Programming
  - **STAMIS:** Standard Army Management Information Systems
  - **STARS:** Surveillance Target Attack Radar System
  - **STRI:** Simulation, Training and Instrumentation
  - **TATRC:** Telemedicine and Advanced Technology Research Center
  - **TRADOC:** U.S. Army Training and Doctrine Command
  - **USAARL:** U.S. Army Aeromedical Research Laboratory
  - **USACEHR:** U.S. Army Center for Environmental Health Research
  - **USAMMA:** U.S. Army Medical Materiel Agency
  - **USARIEM:** U.S. Army Research Institute of Environmental Medicine
  - **UAS:** Unmanned aircraft systems
  - **UCS:** Unified Command Suite
  - **WIN-T:** Warfighter Information Network - Tactical
  - **WMD:** Weapons of mass destruction
  - **WRAIR:** Walter Reed Army Institute of Research



the Army Acquisition Corps as a cadre of elite acquisition professionals, both military and civilian, that would serve as the training ground for critical acquisition positions at the top levels of Army acquisition.

Over the past 25 years, a number of acquisition reform recommendations have focused on making incremental improvements to various aspects of the acquisition process, including organization, budget and requirements. The 1993 Section 800 Report streamlined acquisition laws by reviewing legislation and recommending repeals or amendments. Also in 1993, the National Performance Review recommended the use of commercial standards for acquisition programs and ultimately led to the Federal Acquisition Streamlining Act of 1994, which simplified procurement code.

That same year, Secretary of Defense William J. Perry issued a memorandum outlining major changes in the use of military specifications and standards; many saw the existing specifications and standards as imposing unnecessary restrictions, increasing costs and slowing technology development. His memo called for modifying military requirements, changes in configuration control, a reduction in oversight, and a number of new cultural and process approaches required to implement these changes.

Some three years later, Secretary of Defense William S. Cohen issued the Defense Reform Initiative, designed to streamline DOD's organizational structure and business practices. The initiative centered on reforms in acquisition, logistics and financial management, and led to the creation of the Defense Management Council and the Defense Reform Initiatives Office. In 1999, the assistant secretary of the Army for research,

development and acquisition was rechristened the assistant secretary of the Army for acquisition, logistics and technology—and Army RD&A magazine became Army AL&T.

In late 2001, Secretary of Defense Donald H. Rumsfeld, speaking at DOD's "Acquisition and Logistics Excellence Week," issued a challenge "to shift [the] Pentagon's resources from bureaucracy to the battlefield, from tail to the tooth." He announced an overhaul of DOD's planning, programming and budgeting system and called for increased business agility and tapping private-sector business expertise to help streamline the acquisition process and spur innovation in the supplier base.

Five years later, the 2006 Defense Acquisition Performance Assessment Report proposed changes to the acquisition process that would improve DOD's ability to deliver capabilities to the warfighter by stabilizing and integrating all six elements of the acquisition system: organization, workforce, budget, requirements, acquisition and industry. In the past, acquisition had taken place in a global environment dominated by only a few strategic threats. However, the assessment concluded, the current security environment presented dynamic security challenges and rapidly changing needs, and the acquisition process needed flexibility and agility to respond to those issues.

In 2009, Congress passed the Weapon Systems Acquisition Reform Act, changing the way the Pentagon contracts and purchases major defense acquisition programs to reduce procurement costs. The legislation created DOD's Office of Cost Assessment and Program Evaluation to analyze new program costs, increasing the emphasis on testing new weapons before they enter production.

Defense procurement now accounts for roughly 10 percent of discretionary federal spending, making it a popular target in the current climate of declining budgets and shifting overseas military operations. In March 2014, Rep. Mac Thornberry, R-TX, held the first hearings of a 14-month bipartisan initiative in the House Armed Services Committee that focuses on reforming defense acquisition. Among the issues under consideration are improvements in recruiting, training and developing the acquisition workforce; empowering key acquisition personnel to make effective decisions; enhancing technical expertise needed to support successful acquisition projects; and improvements in planning, contracting and managing services contracts.

---

*MR. STEVE STARK provides contracting support to the U.S. Army Acquisition Support Center (USAASC) for SAIC. He holds an M.A. in creative writing from Hollins University and a B.A. in English from George Mason University. He has worked in a variety of positions supporting communications for the Army and Navy, and has written about defense-related topics for more than a decade. He was the founding editor of the Program Executive Office Soldier Portfolio and edited the Army's Weapon Systems handbook for six years.*

*MS. SUSAN L. FOLLETT provides contracting support to USAASC for SAIC. She holds a B.A. in English literature from St. Lawrence University. She has more than two decades of experience as a journalist and has written on a variety of public and private-sector topics, including modeling and simulation, military training and technology, and federal environmental regulations.*

# FACES

## *of the* FORCE

When Army Acquisition Workforce personnel go to work in the morning—or in the middle of the night—they do it all over the world, and for one reason: because it matters. For all the singular focus on the mission—supporting the Soldier—the things the workforce does are as diverse as the locations and people themselves. As we celebrate the 25th anniversary of the birth of the Army Acquisition Corps, it makes sense to have a look inside those varied workplaces, and let these photos tell at least part of the story of acquisition excellence. For more information about the photos, and to see more photos, have a look at the online extras at <http://usaasc.armyalt.com/> and at the Flickr album at <https://www.flickr.com/photos/usaasc/sets/>.



### PRINTING MUSCLE

Research fellow Dr. Young Joon Seol works on a project to print experimental muscle tissue for reconstructive surgery.

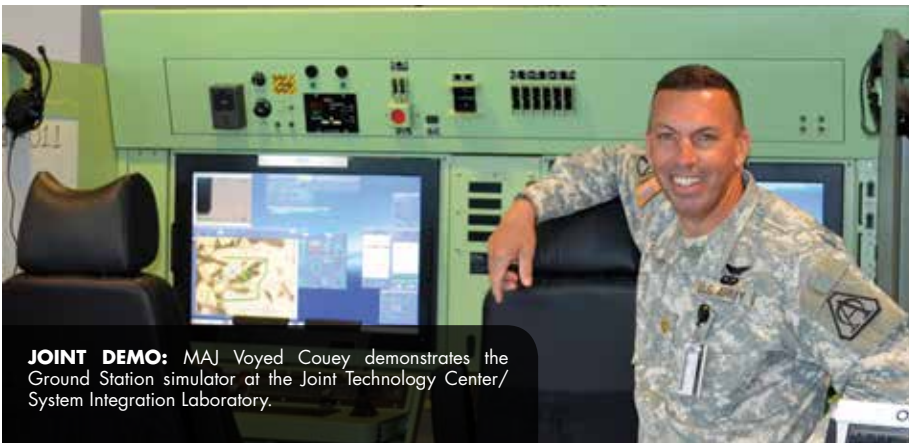

**JOINT DEMO:** MAJ Voyed Covey demonstrates the Ground Station simulator at the Joint Technology Center/System Integration Laboratory.



**COMMAND WEB:** Joe Sladewski, technical lead for PdM Tactical Mission Command.



**STEM OUTREACH:** Product Director for Defense Wide Transmission Systems.



**BENDING METAL:** Bob Jones, a sheet metal worker at Tobyhanna Army Depot (TYAD), reviews documents for a renovation.



**HUNTER:** PM Unmanned Aerial Systems (UAS) Modernization group photo with Hunter, a tactical UAS.

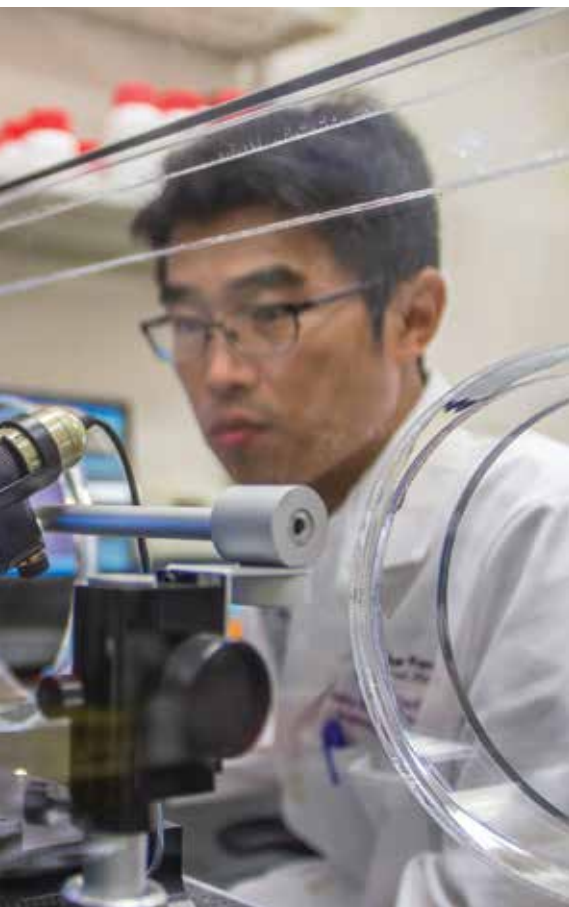

**JOINT EXERCISE:** Rob Malone, right, Joint Project Manager for Elimination, and Ray Diberado of ECBC work aboard the MV Cape Ray in Spain.



**EYE PROTECTION:** Brian Kimball, U.S. Army Natick Soldier Research, Development and Engineering Center, works to advance laser eye protection.



**CHESS MATCH:** Computer Hardware Enterprise Software and Solutions (CHES) customer support representatives provide a CHES IT e-mart tutorial.

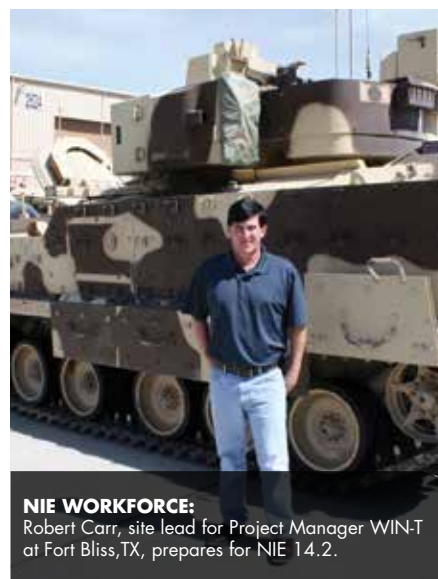

**NIE WORKFORCE:** Robert Carr, site lead for Project Manager WIN-T at Fort Bliss, TX, prepares for NIE 14.2.



**SHOP TALK:** COL Courtney Cote, PM UAS.



**DOCUMENT CHECK:** PM AcqBusiness staff review software documentation to identify capabilities and features.



**CBRNE DESTRUCTION:** Team CBRNE (chemical, biological, radiological, nuclear and explosives) demonstrates a trainer during Capabilities Showcase at Edgewood, MD.



**OPENING CEREMONY:** Rich Kretschmar, center left, LTC Robb Walker and LTC Nick Kioutas participate at Military Appreciation Day during opening ceremonies at an Auburn University football game.



**SITUATIONAL AWARENESS:** Brian Aschle works with Joint Battle Command – Platform in preparation for NIE 14.2 at Fort Bliss.



**RACK AND STACK:** Chuck McFadden, left, and Ryan Plesniarski at work in the PEO C3T Tactical Systems Integration Facility at Aberdeen Proving Ground, MD.



**JEM SUPPORT:** JEM personnel support the JEM UFE at the SPAWAR Systems Center Pacific, San Diego, CA.



**BRIEFING:** Eddie Adams provides an overview briefing to PM UAS leadership at Fort Irwin, CA.



**REFLECTIONS:** Crew members from Product Manager for Wideband Enterprise Satellite Systems build a new Modernization of Enterprise Terminals antenna at Fort Detrick, MD.



**ALL HANDS:** PM DCATS all-hands meeting brings the shop together to take stock and recognize performance.



**OUTTA HERE:** Ty Butler makes contact during PM UAS softball game.



**THE GYROSCOPE PROJECT:** TYAD Electronics Mechanic Pam Eisenhauer takes part in rebuilding hundreds of legacy gyroscopes as part of a short-notice, short-term project.



**CHINOOK FIELD MAINTENANCE:** SPC Nicholas Marsnix, 101st Airborne Division, works on a Chinook engine at Bagram Airfield, Afghanistan.



**WIN-T TALK:** COL Ed Swanson, left, project manager for Warfighter Information Network – Tactical (WIN-T), speaks to Soldiers participating in the WIN-T Increment 2 Developmental Test 2 at White Sands Missile Range, NM.



**CERTIFIED:** LTC Tony Davila presents Jessie Guthrie with a certificate of training for the Advanced Composite Repair class.



**ON-THE-JOB TRAINING:** John Shea provides new equipment training for the final fielding of the M26 Joint Service Transportable Decontamination System.



**WAFER RESEARCH:** Researcher Kate Laflin examines a wafer at the ARL Photo Lithography Lab.



**DUNK THE BOSS:** COL Tim Baxter and deputy Rich Kretzschmar participate in PM UAS' Dunk Your Boss Day.



**SENTINEL RADAR ROLLS OFF PRODUCTION LINE:** Dale McClanahan leads a Letterkenny Army Depot tour for BG L. Neil Thurgood, PEO Missiles and Space.

# THE FULL TREATMENT

Medical Command conducts comprehensive overhaul of acquisition specialties

*by Ms. Dawn L. Rosarius*



## POLICY MAN

Ash Ficklin is a program advisory specialist with USAMRMC and an OAP. Curing what ailed MEDCOM necessitated writing policies, updating TDAs and PDs, educating the workforce and supervisors on responsibilities, and engaging leadership. That task fell to AWF personnel like Ficklin. (Photo by Sidney Hines, USAMRMC Public Affairs)

In a large organization such as the Army, keeping track of the acquisition workforce (AWF) can be daunting, particularly when the workforce is responsible to such a diverse and evolving organization as the U.S. Army Medical Command (MEDCOM). With a mission to influence health to improve readiness, save lives and foster wellness among all those entrusted to our care, MEDCOM has a diverse workforce including clinicians, logisticians, program managers, Ph.D. scientists and engineers. The command is also evolving to support the outcomes of the most recent conflicts and preparing for future conflicts, while transitioning some of its mission to the new Defense Health Agency.

The MEDCOM AWF is, in some ways, a miniature version of the Army AWF. It consists of nearly 850 Soldiers and civilians in 10 career fields: financial management, contracting, purchasing, engineering, information technology, life-cycle logistics, facilities management, program management, science and technology (S&T) management, and test and evaluation.

Where the MEDCOM AWF staff differs is in the additional education and degrees they carry; some have M.D.s, and many have Ph.D.s in microbiology, biochemistry, bioengineering, veterinary medicine or entomology. In addition, the MEDCOM AWF is

not only driven by the DOD 5000, but also must adhere to requirements of the U.S. Food and Drug Administration. The MEDCOM AWF has a responsibility to sustain and save lives, supporting both the clinician and the warfighter by developing, fielding and sustaining the best medical solutions available. These solutions include better vaccines, drugs and medical devices to prevent, mitigate or treat warfighters' injuries and illnesses, as well as obtaining and sustaining medical care in both brick-and-mortar hospitals and the field environment.

Understanding and appreciating how the MEDCOM workforce fits into the larger acquisition picture has been a challenge. This was evident in January 2013, when the Army queried all of its AWF members on the status of their certifications. The assistant secretary of the Army for acquisition, logistics and technology (ASA(ALT)) leadership asked each organization, including MEDCOM, to provide a plan of action for each team member who was delinquent in achieving the required certification. MEDCOM AWF identified 85 delinquent AWF members (about 8 percent of the MEDCOM AWF) and realized that success in certifying the AWF would require a renewed commitment and a detailed plan of action.

### NEW POLICIES NEEDED

The acquisition career management advocate (ACMA) and the organizational acquisition point of contact (OAP) determined that the solution would have to start from the ground up—writing policies, updating tables of distribution and allowances (TDAs) and position descriptions (PDs), educating the workforce and supervisors on responsibilities, and engaging leadership. This was not a problem that MEDCOM could ignore.

**FIGURE 1**

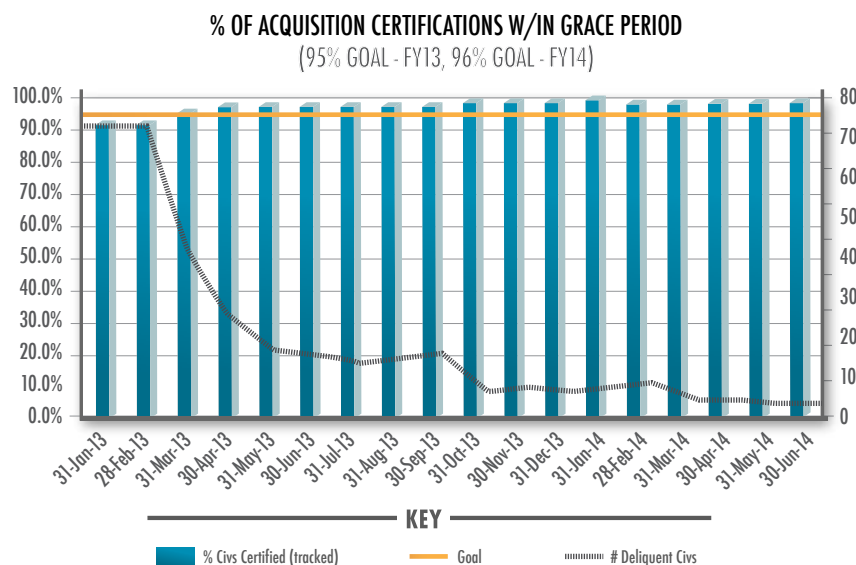

### BY THE NUMBERS

As a result of its overhaul of AWF policies and procedures, over the past 18 months, MEDCOM's rate of delinquency in required certifications has dropped from 8 percent to 1 percent. (SOURCE: MEDCOM ACMA)



### BRIEFING THE BOSS

The Hon. Heidi Shyu, ASA(ALT), listens as Alan Harner, product manager in the U.S. Army Medical Materiel Development Activity's Medical Support Systems Project Management Office, explains the process for improving infectious disease prevention methods, such as uniform repellent, during a visit to USAMRMC. (Photo by Adam Wyatt, Telemedicine and Advanced Technology Research Center Public Affairs)





**TEAM 2020**

MEDCOM established the Workforce 2020 Project (WF 2020) to identify and develop process improvements, which will inform workforce restructuring decisions. The team, with more than 45 members at three locations, includes, from left, Helen Edwards, MEDCOM medical services portfolio manager; Debra Caraway, Jeff Matney and LTC Charles Burton of the U.S. Army Medical Department Transformation Directorate's Program Management Office; Carey Klug, director of AMEDD Transformation; and Nancy Quick, MEDCOM Civilian Corps specific branch proponent officer. (Photo by Dr. Valecia Dunbar, Army Medicine Public Affairs)

MG Joseph Carvalho Jr., the deputy for medical systems in the Office of the ASA(ALT) (OASA(ALT)) and commanding general of the U.S. Army Medical Research and Materiel Command (USAMRMC), provided guidance and support for this overhaul and requested support from fellow MEDCOM leaders. USAMRMC is a major subordinate command of MEDCOM.

Following a meeting with the U.S. Army Acquisition Support Center (USAASC) in February 2013, the ACMA and OAP established two integrated product teams (IPTs) to explore the need for new policies and updating TDAs and PDs. The IPTs included the Army's military consultant for acquisition, acquisition staff from 10 of MEDCOM's major subordinate commands, and key acquisition, human resources, manpower and resource management leaders from across MEDCOM.

The Policy IPT's focus was twofold. First, MEDCOM required a policy for the workforce members, supervisors and respective commands regarding certification and continuous learning points (CLPs) to meet the guidance from the Army director of acquisition career management. Second, the IPT addressed the need for a policy with a more global focus, properly denoting which positions to code as acquisition and the requirements to obtain ACMA approval for any updates to the TDAs. By properly aligning positions to the appropriate TDA, MEDCOM is identifying and developing better career paths and career ladders for the workforce. Both policies were approved and distributed by the end of August 2013.

The TDA IPT had even more of a challenge—to review all MEDCOM TDAs and recommend updates for both military and civilian acquisition positions. The goal for this IPT was not only to properly code the acquisition positions, but also to create career ladders, establishing a structure of professional growth for the 10 civilian acquisition career fields in MEDCOM. During phase one of this process, the IPT focused on all military and seven of the 10 civilian career fields. Phase two is addressing the other three fields.

This process took approximately one year, with support from key acquisition leaders and MEDCOM participants in manpower and resource management. Although the career ladders still need enhancing, especially for the civilian AWF, the initial and most critical step—to capture and properly document existing AWF positions—is complete for phase one. With USAASC's approval, the updates will be part of the FY16 TDA.



### CHILLING

Bruce Cadarette of the U.S. Army Research Institute of Environmental Medicine at Natick Soldier Systems Center, MA, monitors volunteers in Mission Oriented Protective Posture 4 gear during testing of a body-worn microclimate cooling system for helicopter aircrew members. Environmental medicine is one of a host of specialties within MEDCOM, all supported by the 850-strong MEDCOM AWF. (U.S. Army photo)

### CONTINUED OVERSIGHT

As this effort progresses, we are working to ensure that all MEDCOM AWF members and their supervisors understand their responsibilities and opportunities, including application to positions on the Centrally Selected List, funding from the Acquisition Tuition Assistance Program and attendance at leadership training, among many others.

As we add and update TDAs and PDs, a deliberate assessment of the workforce continues regarding certification and CLPs. The ACMA and OAP conduct monthly reviews of each and send monthly reminders to AWF members and their supervisors to ensure completion

of requirements. As a result, in the 18 months since initiation of this overhaul, the delinquency rate has dropped from 8 percent to 1 percent.

MEDCOM AWF members are now becoming more aware of their requirements and what they need to obtain and sustain certification. For example, the ACMA notifies those not meeting the CLP glide path every month, and the OASA(ALT) deputy for medical systems/commanding general, USAMRMC notifies senior leadership (at the two-star level) quarterly. As of the end of June 2013, 63 percent of the MEDCOM AWF was meeting the glide-path targets; a year later, 94 percent were on target and 86

percent had met their CLP requirement. (See Figure 1 on Page 133.) Tenacity, education and frequent reminders from the ACMA and senior leadership have proven to be extremely helpful.

Of the 505 MEDCOM AWF members who are eligible to join the Army Acquisition Corps (AAC), 232 have obtained membership. However, one of the remaining challenges for our engineers and biomedical scientists is the AAC requirement to obtain 12 to 24 business credits. As a result, in FY14 MEDCOM requested and received money from the Defense Acquisition Workforce Development Fund (DAWDF) to support this requirement. To date, 11 MEDCOM

## IN THE 18 MONTHS SINCE INITIATION OF THIS OVERHAUL, THE DELINQUENCY RATE HAS DROPPED FROM 8 PERCENT TO 1 PERCENT.

AWF members have attended courses to obtain business credits and soon will be AAC members. For FY15, MEDCOM AWF members are encouraged to request funding via the Acquisition Tuition Assistance Program. The MEDCOM AWF has increased its number of AAC memberships and hopes to add another 40 to 50 people to the AAC over the next year.

MEDCOM is also using DAWDF money to support its leadership and retention programs. Before FY14, Army Medicine did not engage in the DAWDF program, but in the past year, MEDCOM has identified significant opportunities for the workforce to assist with retention and career development.

### LESSONS LEARNED

During this process, MEDCOM has learned many lessons, key among them the importance of educating and involving essential stakeholders throughout the process. These lessons are helping MEDCOM create a foundation for a more comprehensive understanding of the acquisition workforce. That, in turn, is leading to more educated leadership and a workforce that understands the importance of big “A” acquisition (not just contracting), including all 10 of the acquisition career fields.

The following lessons will help us move forward in managing the MEDCOM AWF:

- Keep leadership informed and engaged—This effort received

significant support from leadership at the two-star level because they believed in the AWF and received regular updates throughout the process, at least quarterly and more frequently in some cases.

- Involve manpower leaders early and often—They are experts on the TDA process, and engaging them helped turn this project around in a year.
- Involve USAASC and ASA(ALT)—Engage them early in the process, keep them updated on recommended changes, and solicit guidance and input throughout.
- Involve human resource (HR) professionals from MEDCOM and USAMRMC—Their expertise was crucial to understanding the details of updating the acquisition information in PDs and helping leaders make changes. Keeping the correct HR personnel engaged remains a challenge given the many groups involved, but we are moving forward with educating and supporting each supervisor and team.
- Locate key acquisition points of contact at regional locations and get commitment from their commands—MEDCOM is a large organization with subordinate activities across the world. This presented a challenge when trying to educate and support all the AWF members and their supervisors effectively. During the past 12 months, personnel at six locations, with more than 20 AWF members each, identified possible OAPs to ensure that the staffs of their respective organizations

were meeting job requirements.

- Educate, educate, educate—From understanding their role in the AWF, to navigating the Career Acquisition Management Portal, to obtaining certification and CLPs, it can be hard for new and existing AWF members to fully comprehend their role. In response to this concern, the ACMA is conducting site visits, where feasible, to educate and support the team and leadership.

### CONCLUSION

While MEDCOM is evolving, so has its AWF. The command has rejuvenated leadership and the AWF to properly document, educate and support workforce members. The AWF is now more engaged and is becoming better educated to support the clinician and the warfighter with its mission of developing, fielding and sustaining the best medical solutions across the globe. We still have work to do, but we are on the path to success.

*For more information, contact the author at [dawn.l.rosarius.civ@mail.mil](mailto:dawn.l.rosarius.civ@mail.mil).*

---

*MS. DAWN L. ROSARIUS is the civilian deputy principal assistant for acquisition and MEDCOM acquisition career management advocate, USA, Fort Detrick, MD. She holds an M.S. in technology management, with a concentration in biotechnology, from the University of Maryland, an M.S. in national resource management from the National Defense University's Industrial College of the Armed Forces, and a B.S. in electrical engineering, with a minor in mathematics, from Loyola College. She is Level III certified in the fields of program management; life-cycle logistics; S&T manager, and systems planning, research, development and engineering. She is a Project Management Professional and a member of the Army Acquisition Corps.*



TRANSFORM

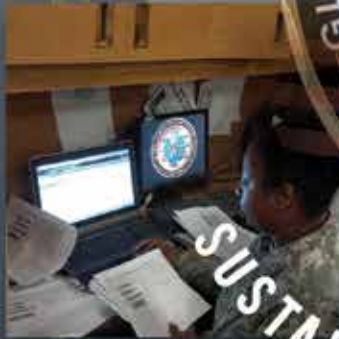

SUSTAIN



INTEGRATE

# THE ARMY'S ONE SOURCE FOR TACTICAL LOGISTICS & FINANCIAL INFORMATION

GCSS-Army has developed a single, Web-based system that will replace the suite of current tactical logistics and financial management information systems throughout the Army. Commanders will have near-real-time integrated information, total asset visibility, and property and financial accountability for rapid and effective decision-making in a fluid environment. Soldiers will efficiently accomplish their specific missions throughout the entire sustainment structure. GCSS-Army has re-engineered and streamlined labor-intensive processes, freeing Soldiers to perform other important duties.



[www.gcss.army.mil](http://www.gcss.army.mil)





## CAREER CORNER

### USAASC PERSPECTIVE

FROM THE DIRECTOR,  
U.S. ARMY ACQUISITION SUPPORT CENTER

# THE ARMY ACQUISITION CORPS: EVOLVING EXCELLENCE

Since its launch a quarter of a century ago, the Army Acquisition Corps (AAC)—spanning four presidential administrations, eight defense secretaries, 13 secretaries of the Army and eight Army chiefs of staff—has evolved into a highly qualified, well-educated, competitive, competent and experienced workforce of more than 38,000 acquisition professionals.

In a 1990 memo, then-Army Chief of Staff GEN Carl E. Vuono introduced the AAC to the force, writing, “The AAC will enhance and sustain the acquisition skills of a select group of officers with a solid foundation of operational experience and civilian specialists with proven technical experience. The program will integrate education, training, assignments and promotion for military and civilian members of the AAC.”

Now, 25 years later and with the subsequent passage of the Defense Acquisition Workforce Improvement Act (DAWIA), Vuono’s vision—a workforce of acquisition professionals working persistently to deliver the latest weapon systems, equipment, and products and services to the



**Craig A. Spisak**  
*Director, U.S. Army  
Acquisition Support Center*

best fighting force in the history of the world—has become reality. (See Figure 1.)

### **BUILDING ON THE FOUNDATION**

In its early days, the AAC’s primary focus was on creating the foundational training, education and experience qualifications to meet the DAWIA professional standards set for the Acquisition Workforce. In 25 years, that qualifications focus has progressed dramatically to include improving the competency of the workforce.

One of the things that we’re proud of in our business is that we’re constantly assessing best practices and lessons learned to decide what skill sets are necessary to improve capabilities. We have grown from providing the workforce with the basic training and education qualifications to offering them the tools (opportunities, education and leadership development) not only to stay current, but also to excel and become experts in their particular acquisition discipline.

Over the decades, training, education and providing experience to the workforce have changed accordingly. Contingency contracting operations have developed exponentially, starting with a few during the Persian Gulf War in 1991 and then increasing after 2001 with the growing operations tempo of Operations Enduring Freedom and Iraqi Freedom. We now have different strategies on hardware, software and information systems testing, new approaches in program management, new technology in the engineering field and more contractor logistics support. It’s easy to see how things have changed across every acquisition career field and to understand why we have to constantly



FIGURE 1

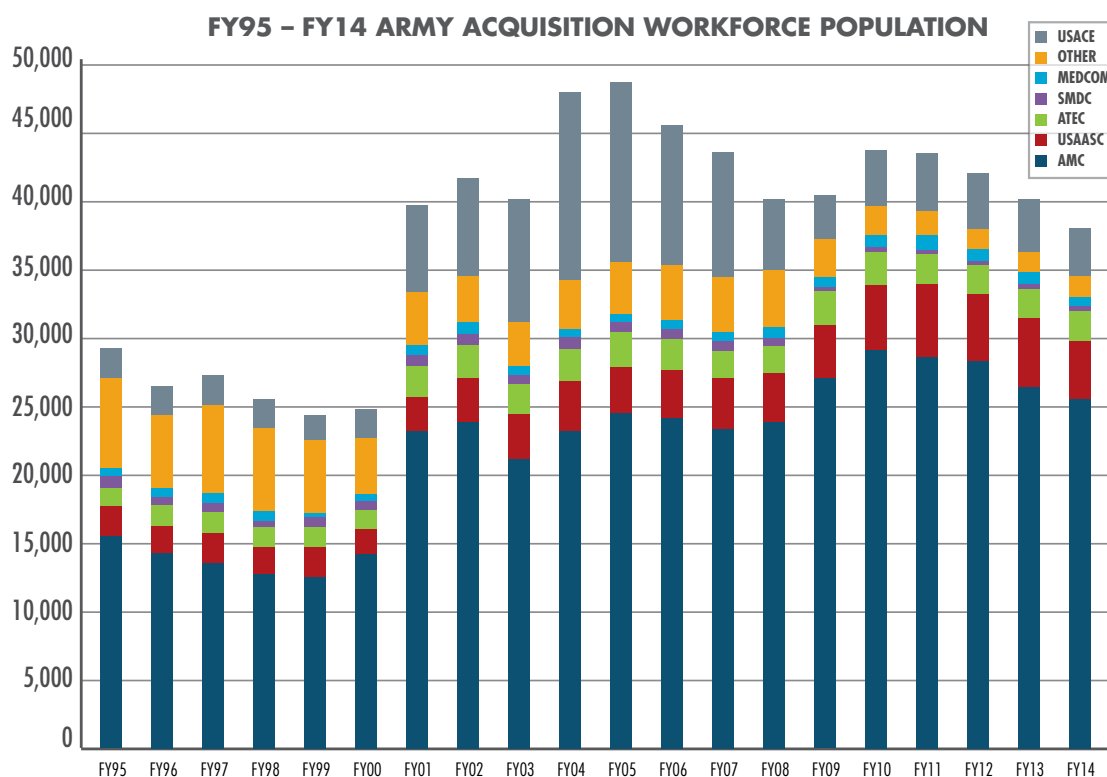

#### FORCE MULTIPLIER

The Army Acquisition Workforce has responded to the needs of warfighters on the battlefield for the past 25 years and will continue to do so, strengthened by the right kinds of training, education and developmental experiences. (SOURCE: Defense Manpower Data Center and Career Acquisition Management Portal)

train, educate and provide different types of experiences to keep the Army Acquisition workforce relevant.

#### PEOPLE FIRST—ALWAYS

Taking care of the people of the Army Acquisition Workforce—giving them the tools to succeed—has been a consistent theme since the AAC’s beginning. In fact, Vuono talked in his memo about needing qualified people to do the acquisition job.

Over the years, I think smart and good leaders have recognized that our business gets done by people. I don’t care if you say

the mission comes first—the people performing that mission are the ones getting it done. The AAC has always recognized that if you want to achieve significant, long-lasting outcomes, you must put people first by providing them the tools to build successful acquisition careers.

Those tools come in a wide variety of categories, including training, education and experience opportunities that the individual can take advantage of as well as basic tools, like a safe working environment and a high-quality workspace with the necessary equipment to do the

job. Can you imagine working without those tools at the fast pace we have today? When I started in this business in the ’80s, I was one of the first to get a computer at my desk, and it made a huge difference in my job performance.

These are just a few reasons why I believe that “people first” will continue to be the unwavering theme of the AAC.

#### AAC LEGACY

On Oct. 12, 1989, one day before the AAC’s establishment, the same people were performing the same functions

they'd be tasked with on Oct. 13. They were simply recognized as a community. Good engineers and scientists on Oct. 12 were still good engineers and scientists on Oct. 14.

I believe the AAC legacy will be what this community brings to the fight. The Army Acquisition Workforce is a group of very dedicated, highly skilled and proficient professionals with an incredibly huge force-multiplier effect. This group is responsible for the business side of the Army. The acquisition community by far implements the largest portion of the Army's discretionary funding—consistently, effectively and efficiently. In FY14, roughly \$19 billion was appropriated for Army acquisition.

I'm confident that in the next 25 years, ours will continue to be the best-equipped army in the world with no match on the battlefield, and that our Army acquisition community will continue to adapt rapidly and readily to the changing threats on the

battlefield. Over the past 10 years, we saw the need for Mine Resistant Ambush Protected vehicles, and we quickly put them in the field. We answered the call again in quickly deploying unmanned aerial vehicles. That agility will only grow.

**CONCLUSION**

The Army Acquisition Workforce helps prepare the Army to dominate the battlefield. We are the ones who provide warfighters the systems, logistics, technology and services to help them get the job done in a hostile environment.

Who knows what the world situation will be over the next 25 years? We do know that every current and future member of the Army Acquisition Workforce will continue to be an important link in the chain. We all have a stake in the Army's success, now and in the future.



DESIGN • DEVELOP • DELIVER • DOMINATE

**ARMY AL&T**

**ONLINE**

usaasc.armyalt.com

**ON THE GO**

Download the Mobile app





**SECTION 3685, TITLE 39, U.S.C.**

**SHOWING OWNERSHIP, MANAGEMENT AND CIRCULATION**

Army AL&T is published quarterly by the U.S. Army Acquisition Support Center, 9900 Belvoir Road, Suite 201, Fort Belvoir, VA 22060-5567. The Editor-in-Chief of Army AL&T is Nelson McCouch and the publisher is the Office of the Assistant Secretary of the Army for Acquisition, Logistics and Technology, 103 Army Pentagon, Washington, DC 20310-0103.

<b>Average number of copies each issue during the previous 12 months:</b>	<b>Actual number of copies of single issue (Jul-Sep 2013) published nearest to filing date (Aug. 1, 2013):</b>
<ul style="list-style-type: none"> <li>• Total number of copies printed (net press run): 6,187</li> <li>• Total free or nominal rate distribution: 6,187</li> <li>• Total distribution: 6,187</li> <li>• Copies not distributed: 30</li> <li>• Total: 6,157</li> </ul>	<ul style="list-style-type: none"> <li>• Total number of copies printed (net press run): 6,305</li> <li>• Total free or nominal rate distribution: 6,305</li> <li>• Total distribution: 6,305</li> <li>• Copies not distributed: 30</li> <li>• Total: 6,275</li> </ul>

# ACQUISITION CAREER, ANYONE?

Army DACM Office guides success

*by Mr. Robert E. Coultas*



## THE GO-TO OFFICE

For anything related to careers in Army acquisition, the DACM Office is the place to go. The office supports the career development and certification of the approximately 38,000 military and civilian personnel who make up the Army Acquisition Workforce (SOURCE: USAASC).

The successful career of an Army acquisition professional is based fundamentally on individual ambition, seeking challenges along with progressive training and education—and acquisition professionals are not alone in fulfilling their ambitions.

The Army provides the tools and opportunities through its director, acquisition career management (DACM). The DACM is responsible for ensuring the career development and certification (through training, education and experience) of the approximately 38,000-strong military and civilian Army Acquisition Workforce as required by the Defense Acquisition Workforce Improvement Act (DAWIA). These acquisition professionals work worldwide in Army staff offices, Army commands, Army service component commands, program executive offices and direct reporting units.



FIGURE 1

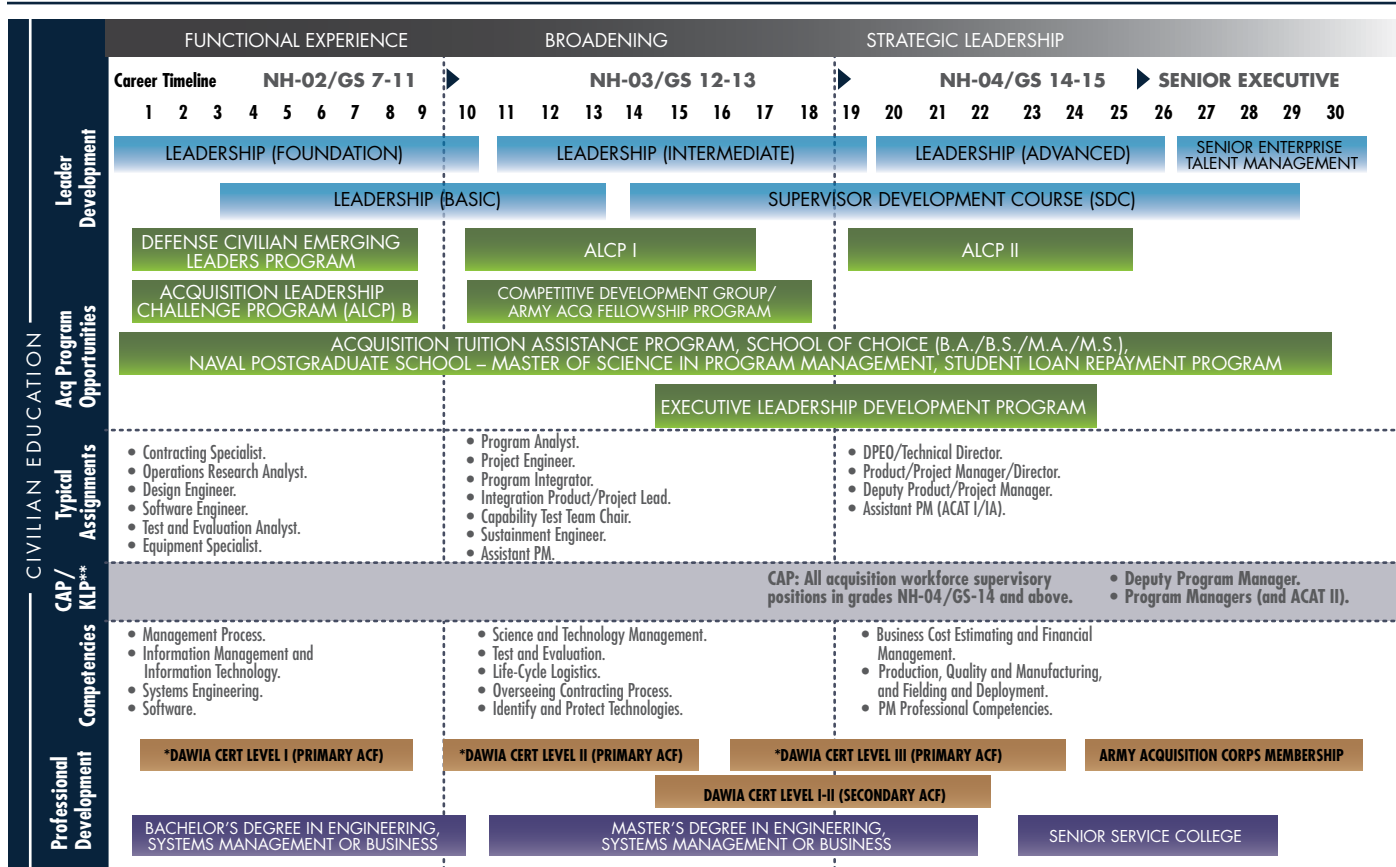

\*Indicates Mandatory Requirement \*\* ACAT I/IA

MOVING RIGHT ALONG

Civilian acquisition workforce members now have career models specific to their ACF, such as this one for program management, including progressive opportunities in the broad categories of functional experience, broadening and strategic leadership. (SOURCE: USAASC)

**“THE GOAL IS TO CREATE AND MAINTAIN A HIGH-PERFORMANCE, SUSTAINABLE ORGANIZATION THAT MEETS ITS STRATEGIC AND OPERATIONAL GOALS AND OBJECTIVES.”**

LEADERSHIP

On April 4, LTG Michael E. Williamson became the new principal military deputy to the assistant secretary of the Army for acquisition, logistics and technology (ASA(ALT)) and the DACM. Craig A. Spisak, director of the U.S. Army Acquisition Support Center (USAASC), serves as the deputy DACM; as such, he leads the office mission and provides oversight of the Army Acquisition Corps (AAC) and Army Acquisition Workforce. The Army DACM Office works with the Defense Acquisition University

(DAU), the assistant secretary of defense for acquisition and the undersecretary of defense for acquisition, technology and logistics (USD(AT&L)) to support workforce initiatives and to advocate for the Army Acquisition Workforce. Under DAWIA, with its goal of professionalizing the Defense Acquisition Workforce, the Army DACM Office provides support for anything acquisition career-related.

PROFICIENCY

The Army DACM Office is data-driven, proactively identifying acquisition

workforce trends and challenges for our leaders while providing career support to the Army Acquisition Workforce. According to Joan Sable, USAASC's Acquisition Career Development Division chief and Army DACM Office team chief, the efforts of the Army DACM Office over the years have cultivated the proficiency of the workforce.

“As a result of the focus of the Army DACM Office on increasing the professionalism of the acquisition workforce, the certification rate among the workforce is the highest in the 25-year history of the Army Acquisition Corps,” Sable said, with 97 percent certified or within the grace period for certification as of July 31.

The DACM Office also maintains the central repository for all acquisition workforce members' data via the Career Acquisition Personnel & Position Management Information System, and is responsible for ensuring adherence to DAWIA statutory requirements for acquisition career field (ACF) certification and continuous learning.

### PROPNENCY

The Army DACM Office provides a team of proponency officers who serve as advocates for ACFs and partner within the Army and DOD to ensure synergy among acquisition functional areas. Military proponency spans Functional Area 51 in the active and reserve components as well as the military occupational specialty (MOS) 51C in the NCO community. In fact, since 2007, a year after 51C became a new MOS, Army DACM Office reclassification efforts have grown the MOS 51C NCO population from 63 to 474 at the end of FY13.

The Army DACM Office appoints Army acquisition functional advisers (AAFAs)



AUDITING



BUSINESS –  
COST ESTIMATING



BUSINESS –  
FINANCIAL MANAGEMENT



CONTRACTING



ENGINEERING



FACILITIES ENGINEERING



INDUSTRIAL AND  
CONTRACT PROPERTY  
MANAGEMENT



INFORMATION  
TECHNOLOGY



LIFE-CYCLE LOGISTICS



PRODUCTION, QUALITY  
AND MANUFACTURING



PROGRAM MANAGEMENT



PURCHASING



SCIENCE AND  
TECHNOLOGY MANAGER



TEST AND EVALUATION

### MANY FIELDS TO EXPLORE

The DACM Office is responsible for ensuring adherence to DAWIA statutory requirements for ACF certification and continuous learning. (SOURCE: DAU)

who serve as subject-matter experts for their designated ACF and provide functional advice and recommendations to support education, training and career development programs for the acquisition workforce. Together with the AAFAs, proponents participate in periodic DOD functional integrated product teams (FIPTs), advocating the Army's position for acquisition career development. The FIPT's goal is to assist the USD(AT&L) ACF functional leaders with competencies, certification standards, professional currency and all other issues needed to ensure the most effective possible performance of the acquisition workforce. Proponency officers foster partnerships with the other services, represent the Army DACM, develop policies, conduct strategic analyses and promote career developmental training, quality education and professional experience for the acquisition workforce.

### ACQUISITION EDUCATION

DAWIA mandates that acquisition workforce personnel attain certification in their primary ACF by completing training provided by DAU. DAU quota managers (QMs) within the Army DACM Office process every DAU training application submitted by members of the nearly 38,000-person acquisition workforce as well as any non-acquisition Army civilian or service members requesting training.

“We owe a huge part of the great certification compliance success to our few dedicated QMs. Without their hands-on application evaluation and processing, we would not have attained such high compliance rates over the past four years,” said Sable. “When someone applies for a class through our DAU online registration system, a QM reviews each application. Because of the various requirements of each class, applications still need that

FIGURE 2



**WHAT'S A DAWDF?**

DAWDF, which the Army DACM Office administers, allows DOD to recruit and hire, develop and train, and recognize and retain its acquisition workforce. (SOURCE: USAASC)

human touch to evaluate their validity, priority and merit.”

In addition to the quota management role, the Army DACM Office coordinates annually with DAU and the other services to forecast DAU seats for the upcoming fiscal year. This demand forecast is essential for DAU as it builds the next fiscal year’s schedule to support the workforce’s educational needs.

**TALENT MANAGEMENT**

Developing talent among the Army Acquisition Workforce is a significant mission for the Army DACM Office.

“The goal is to create and maintain a high-performance, sustainable organization that meets its strategic and operational goals and objectives,” said Sable. “The Army DACM Office’s Talent Management Program puts people first by

ensuring that our acquisition workforce [members] are offered the best opportunities, training, education and leadership development, all working toward a successful career, from hire to retire.”

The Army DACM Office has career development tools to help military and civilian leaders develop the acquisition workforce and to guide each workforce member in defining a career path. For the first time,

civilian acquisition workforce members will have career models specific to their ACF. (See Figure 1 on Page 142 for an example.) These models provide a progressive path toward career growth.

Also, the DACM Office offers educational, training and leadership development programs designed for every acquisition career level. These programs include internships, Competitive Development Group/Army Acquisition Fellowship, Acquisition Leadership Challenge (Levels B, I and II), the DAU Senior Service College Fellowship and Training with Industry. See all the programs offered by the Army DACM Office at <http://asc.army.mil/web/career-development/programs/> under Career Development.

### MANAGING FUNDS

Also under the purview of the Army DACM Office is administration of the Defense Acquisition Workforce Development Fund (DAWDF). This funding allows DOD to recruit and hire, develop and train, and recognize and retain its acquisition workforce. The office uses these funds to pilot innovative acquisition-based programs developed by Army commands and organizations to ensure the long-term sustainment of the workforce. (See Figure 2.) Many of these DAWDF-funded pilots have gone on to be best practices leveraged across the acquisition workforce:

- Virtual Acquisition Career Guide—Online platform where acquisition workforce members can engage in dynamic, interactive face-to-face dialogue with a virtual counselor who offers consistent messaging along with personalized career guidance.
- Specialty Engineering and Training Program partnership with ASA(ALT)'s System of Systems Engineering and Integration Directorate—Cooperative



### LOOK AND LEARN

DAU's iCatalog is an easy-to-navigate guide to the certification and continuous learning requirements of various ACFs and the courses available to fulfill those requirements. (Image courtesy of USAASC)

effort to develop and replace talent in three U.S. Army research, development and engineering centers.

- Contingency Contracting Exercise—Annual joint contracting exercise at Fort Bliss, TX, with more than 200 military and deployable civilians; led to a FY14 Joint Staff contracting exercise.
- Predictive Staffing Model—Method of providing program management offices with staffing recommendations based on a program's life cycle, using the Acquisition Workload Based Staffing Analysis Program to capture the hours of work being performed in real time and specific to functions within the Army.

### CONCLUSION

Whether the question is about certification, DAU course scheduling, AAC membership, policy or just advice, the Army DACM Office is the one stop for

the Army acquisition professional for anything career-related.

For more information, go to <http://asc.army.mil/web/dacm-office/>; the DACM News, at <http://asc.army.mil/web/dacm-newsletter/>; DACM Hot Topics, at <http://asc.army.mil/web/category/dacm-topics/>; and the DACM Education and Training Column, at <http://asc.army.mil/web/category/edu-training-column/>.

MR. ROBERT E. COULTAS is the Army AL&T magazine departments editor and an Access AL&T editor. He is a retired Army broadcaster with more than 42 years of combined experience in public affairs, journalism, broadcasting and advertising. He has won numerous Army Keith L. Ware Public Affairs Awards and is a DOD Thomas Jefferson Award recipient

# SUPPORTING THOSE WHO SUPPORT THE WARFIGHTER, *with* **CAREER INFORMATION**

**A**nyone who's watched an airplane safety presentation is familiar with the directive reminding travelers to put on their own air masks on before helping others. In a sense, it's also good career advice: When acquisition professionals are on top of their game, they're better able to help others with their careers. That's where the Army DACM—the Office of Director, Acquisition Career Management—comes in, providing the acquisition workforce with easy-to-find, actionable information on education, training and development.

The website of the U.S. Army Acquisition Support Center (USAASC)—<http://asc.army.mil/web/>—provides acquisition news, the Career Acquisition Management Portal and profiles of people doing a wide variety of vital work for the acquisition workforce. News stories focus on challenges encountered and lessons learned, providing solutions to issues that other acquisition professionals might face in their work.

The website also features a link to the Acquisition Education, Training and Experience Catalog, which provides information on career enhancement opportunities. Tabs at the top of the page take users to frequently asked questions, program executive offices, events and the most important publications from USAASC, including the digital edition of this magazine and the DACM Newsletter.

Additional information is easily accessible from the Career tab at the top of the page or by bookmarking <http://asc.army.mil/web/dacm-office/>, which breaks down career information into civilian and military programs, and features a newly redesigned and updated page on the 51C Active Component Reclassification Program. The DACM Office Web page also provides guidance on putting together individual development plans, applying for training, and acquisition workforce policies and procedures.

For civilian acquisition professionals, the Civilian Career Planning Steps under the Career Development tab

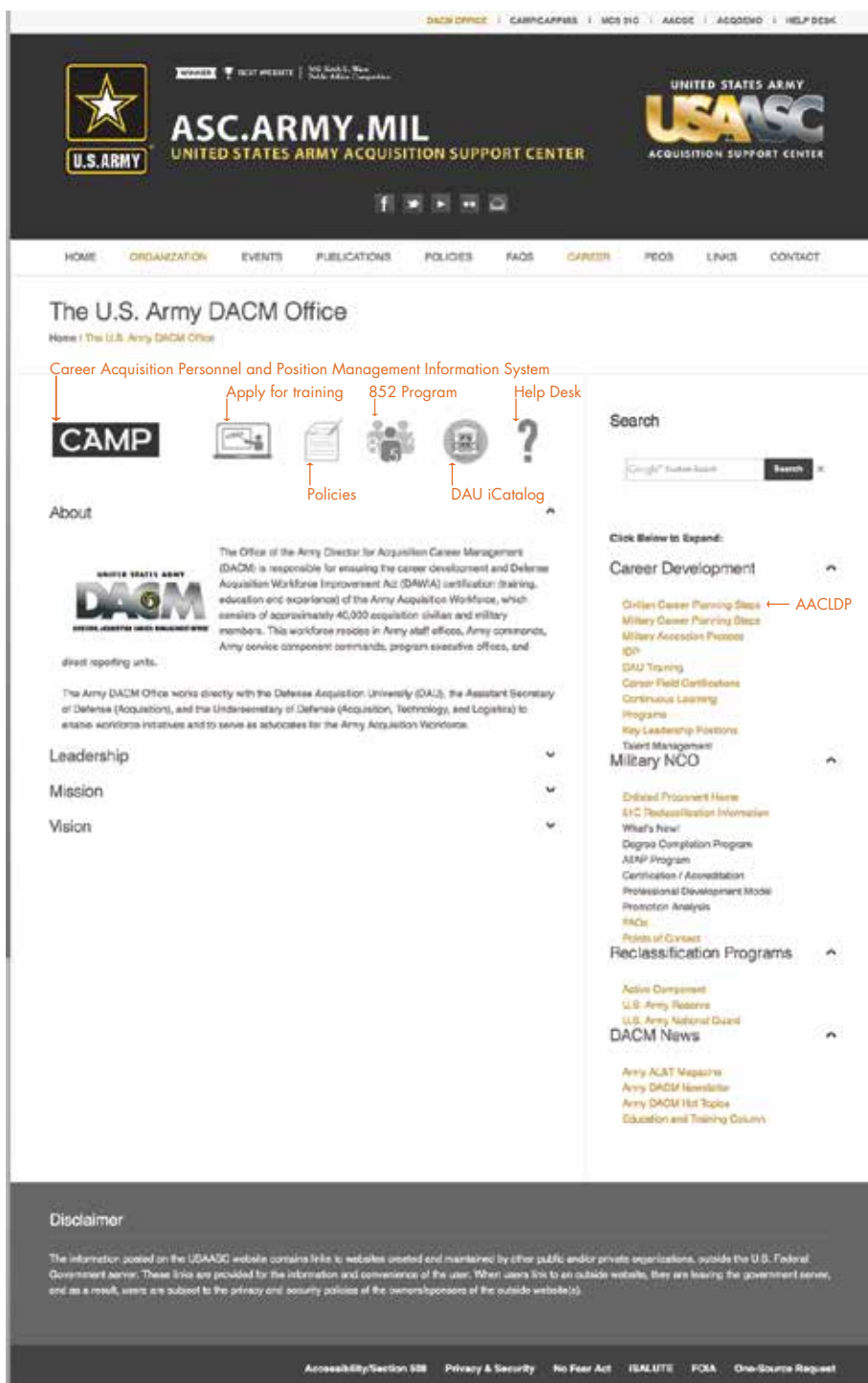

### ONE STOP FOR INFO: ASC.ARMY.MIL

The website of the Army DACM Office is a central location where the Army Acquisition Workforce can find exhaustive detail on career development policy and opportunities. (Image courtesy of USAASC)

outlines the Army Acquisition Civilian Leadership Development Plan, which clearly lays out the statutory certification training and Civilian Education System requirements alongside opportunities for leadership training and higher education. A PDF on the Civilian Career Planning Steps page outlines the certification and continuous learning requirements, with information on the process to follow to meet these requirements.

The Career Development dropdown menu also includes a link to the Defense Acquisition University, which provides mandatory, assignment-specific and continuing education courses for military and civilian acquisition personnel within DOD.

The DACM News link features even more information: the DACM Newsletter and a column from the Army DACM Office with monthly updates on education and training opportunities.

Fellowship programs and leadership seminars can also help with career advancement. Information on such opportunities is available in the Career Development section, or by using the search feature on the right side of the page.

To-the-minute news from DACM and the USAASC are available by following USAASC on **Twitter** (@USAASC) and other social media platforms. Sign up for the Access AL&T news feed when you click on any article on the USAASC site, and have the latest acquisition news delivered to your inbox. As a final note, the Acquisition Corps' version of Monster.com—<http://asc.army.mil/web/usajobs/>—includes job openings for acquisition personnel.

—MS. SUSAN L. FOLLETT

# ON THE MOVE



MG Joseph Carvalho Jr.

## CHANGE OF COMMAND AT USAMRMC

**MG Joseph Carvalho Jr.** relinquished command of the U.S. Army Medical Research and Materiel Command (USAMRMC) and Fort Detrick, MD, to **MG Brian C. Lein**, in a ceremony Sept. 16 at Fort Detrick. Lein comes to USAMRMC from an assignment as the deputy surgeon general and deputy commanding general (CG) for operations for the U.S. Army Medical Command.

A New York native, Lein began his military career at the United States Military Academy at West Point, graduating in 1984 as a Distinguished Military Cadet with a B.S. He earned his medical doctorate from Temple University School of Medicine. He is also board-certified in general surgery. Lein's military education also includes the U.S. Army Command and General Staff College, the U.S. Army War College and the U.S. Army Airborne School.

Carvalho had been the CG of USAMRMC and Fort Detrick since January 2013. As the Army's medical materiel developer, the USAMRMC focuses on medical research, development and acquisition, and medical logistics management, with 12 subordinate commands and six executive agencies around the world.



MG Kevin G. O'Connell

## ASC WELCOMES O'CONNELL AS CG

**MG Kevin G. O'Connell** became CG of the U.S. Army Sustainment Command (ASC) during a change-of-command ceremony at Rock Island Arsenal, IL. O'Connell replaces **MG John F. Wharton**, who had commanded ASC since September 2012. During his tenure, Wharton was instrumental in improving the efficiency of the command's logistics readiness centers while supporting the drawdowns in Iraq and Afghanistan. Wharton assumed command of U.S. Army Research, Development and Engineering Command in a ceremony Sept. 22 at Aberdeen Proving Ground, MD.

O'Connell comes to ASC from U.S. Army Forces Command at Fort Bragg, NC, where he served as deputy chief of staff for logistics, G-4. Previously, he served as CG of the Joint Munitions and Lethality Life Cycle Management Command/Joint Munitions Command (JMC), also headquartered at Rock Island Arsenal. **GEN Dennis L. Via**, CG of the U.S. Army Materiel Command (AMC), presided over the ceremony. ASC, a major subordinate command of AMC, sustains U.S. and joint forces around the globe.



SGM Rory L. Malloy

## MALLOY NAMED AS ASA(ALT) SERGEANT MAJOR

**SGM Rory L. Malloy** has been selected as the sergeant major in the Office of the Assistant Secretary of the Army for Acquisition, Logistics and Technology (OASA(ALT)), Pentagon, Washington, DC, effective Dec. 10. Malloy served as commandant of the U.S. Army Sergeants Major Academy, Fort Bliss, TX, from May 2011 until June 10, when he relinquished leadership to CSM Dennis E. Defreese. As OASA(ALT) sergeant major, Malloy will be the senior enlisted adviser to the Hon. Heidi Shyu, ASA(ALT) and Army acquisition executive, filling a position that has been vacant for several years.



### HUGHES GETS SECOND STAR

BG(P) Daniel P. Hughes became **MG Daniel P. Hughes** on Sept. 2. Hughes, 54, is the Army's Program Executive Officer for Command, Control and Communications – Tactical (PEO C3T), responsible for providing Soldiers with radios, software applications, satellite systems and other tactical network tools they need to communicate on the battlefield. The Pantego, TX, native took command of PEO C3T on Sept. 4, 2013, championing his vision of "simplify, simplify"—to make the Army's secure network as easy to use as the commercial network and devices Soldiers rely on in their everyday lives. Hughes will continue to lead the Army's efforts to modernize the tactical network in support of Force 2025 and Beyond priorities.

"Over the next 10 years, commercial communications technology will continue to revolutionize the way people and governments interact, and to change the way our enemies think," Hughes said. "While the Army has technologies today that we never envisioned in the past, we still face a huge challenge to retain information dominance going forward. I'm honored to have the opportunity to lead that effort."



### HARRISON PROMOTED

The rank of major general is attached to newly promoted **MG Theodore C. "Ted" Harrison** by his mother, Julie, and wife, Wendy, during a July 3 ceremony at Redstone Arsenal, AL. Harrison is CG of the U.S. Army Contracting Command. (U.S. Army photo by Ed Worley)



### PROMOTION FOR CRAWFORD

**MG Bruce T. Crawford**, right, CG of U.S. Army Communications-Electronics Command and Aberdeen Proving Ground (APG), MD, receives his two-star rank during a promotion ceremony July 21 at APG's C4ISR Campus, with **GEN Dennis L. Via**, CG, U.S. Army Materiel Command, presiding. (Photo by Sean Kief, APG Garrison)



### TACOM CHANGE OF COMMAND

**MG Gwendolyn Bingham** addresses the audience after succeeding **MG Michael J. Terry** as CG of the U.S. Army TACOM Life Cycle Management Command at a change-of-command ceremony at Detroit Arsenal in Warren, MI, June 25. **GEN Dennis L. Via**, AMC CG, officiated. Terry retired after 35 years of service during an Aug. 15 ceremony hosted by the 13th Sustainment Command (Expeditionary) at Fort Hood, TX. (Photo by Karen Nemeth, U.S. Army Garrison – Detroit Arsenal)



### CHANGE OF COMMAND AT ASC

**Gen. Dennis L. Via**, right, CG of AMC, passes the ASC flag to **MG Kevin G. O'Connell**, incoming ASC CG, at a change-of-command ceremony at Rock Island Arsenal, IL, Aug. 21. (Photo by Tony Lopez, JMC Public Affairs)





**CHANGE OF CHARTER AT PM DCATS**

**Terry Watson**, center, Deputy PEO for Enterprise Information Systems, recognizes the accomplishments of **COL Clyde E. Richards Jr.**, left, outgoing project manager for Defense Communications and Army Transmission Systems (PM DCATS), during a change-of-charter ceremony Aug. 13. **COL Charles “Charlie” M. Stein**, right, assumed the charter during the ceremony at the Fort Belvoir, VA, Officers’ Club. Watson congratulated Richards for his many accomplishments as PM DCATS, noting in particular his ability to bring people together and create esprit de corps. Richards’ new post is Army portfolio director at the Defense Contract Management Agency.



**CHANGE OF CHARTER AT PM SAI**

**COL Thomas B. Gloor**, left, accepts the charter of the project manager for sensors – aerial intelligence (PM SAI) during a ceremony presided over by **Stephen D. Kreider**, center, Program Executive Officer for Intelligence, Electronic Warfare and Sensors (PEO IEW&S). During the June 23 ceremony, **COL Christopher Davis** turned over leadership of PM SAI, which encompasses five product management offices responsible for fielding systems for manned and unmanned aircraft and tactical exploitation of national capabilities. (Photo by William Schofield)



**PM TACTICAL RADIOS CHANGE OF CHARTER**

**COL James P. Ross** assumed the charter of the project manager for tactical radios from **COL William R. Wygal** at a ceremony Aug. 19 at Aberdeen Proving Ground. **Then-BG(P) Daniel P. Hughes**, Program Executive Officer for Command, Control and Communications – Tactical, presided over the ceremony. Wygal is retiring after more than 30 years of service, with a ceremony planned for Oct. 31 in San Diego, CA.

**COLLINS TAKES THE REINS ON DCGS-A**

**Stephen D. Kreider**, center, PEO IEW&S, presides over a change-of-charter ceremony June 25 at Aberdeen Proving Ground for the project manager for the Distributed Common Ground System – Army, with **COL Charles Wells**, right, departing, and **COL Robert Collins**, left, taking over. (Photo by William Schofield)



**SANCHEZ TAKES CHARTER**

**COL Anthony Sanchez** accepts the charter of the project manager for terrestrial sensors from **Stephen D. Kreider**, PEO IEW&S, at a July 1 ceremony at Fort Belvoir, VA.

**LEE TAKES OVER**

**COL Jong Lee** assumes the charter of project manager for aircraft survivability equipment from **Stephen D. Kreider**, PEO IEW&S, at a change-of-charter ceremony July 30 at Redstone Arsenal, AL. Lee succeeds COL John Leaphart.

**WILLIAMS TAKES CHARTER**

**COL Thomas B. Gloor**, PM SAI, presents the charter of the product director for sensors – unmanned and rotary wing, one of five product management offices under PM SAI, to **LTC Chevonne Williams** during a ceremony July 24 at Aberdeen Proving Ground. (Photo by William Schofield)



### NEW 0-6 AT PEO CS&CSS

**COL(P) Brian P. Cummings**, Deputy Program Executive Officer for Combat Support and Combat Service Support (PEO CS&CSS), presents **COL Paul D. Shuler** with the certificate marking Shuler's promotion to colonel, June 3. (U.S. Army photo)



### CHANGE OF LEADERSHIP AT JTLV-C

**COL John R. Cavedo Jr.**, left, joint project manager for Joint Light Tactical Vehicles, PEO CS&CSS, conducts the change-of-leadership ceremony June 5 for PEO CS&CSS' product director for Joint Light Tactical Vehicle – Charlie. **COL Shane Fullmer** stepped aside and **LTC Anthony Gibbs**, center right, took over. (U.S. Army photo)



### FEATHERS TAKES OVER

The Office of the Product Manager for Medium-altitude Surveillance Systems got a new leader June 20, as **COL Dean Hoffman** departed and **LTC Scott Feathers** took over, during a change-of-charter ceremony hosted by **Stephen D. Kreider**, PEO IEW&S, at Aberdeen Proving Ground.

### GASTAN TAKES OVER AEROSTATS

**LTC Michael Parodi** departed Product Manager Aerostats and **LTC Gregory Gastan** took over Aug. 1, at a change-of-charter ceremony at Aberdeen Proving Ground hosted by **Stephen D. Kreider**, PEO IEW&S.



### CRAFT LEADS PM MRAP

**Scott J. Davis**, left, Program Executive Officer for Combat Support and Combat Service Support (PEO CS&CSS), presents the charter of the project manager for Mine Resistant Ambush Protected (MRAP) vehicles to **COL Jason Craft** at a change-of-leadership ceremony June 27. (U.S. Army photo)



### BIGGANS TO BRIDGING

**LTC Jeffrey Biggans** receives the charter of the product manager for bridging from **Bryan McVeigh**, the project manager for force projection in the PEO CS&CSS, July 17. (U.S. Army photo)



### STEWART IS NEW PM AT PEO CS&CSS

**Scott J. Davis**, PEO CS&CSS, presents the charter of the project manager for expeditionary energy and sustainment systems to **COL Maurice Stewart** at a change-of-leadership ceremony May 16. (U.S. Army photo)



### FRANKLIN LEADS MRAP LOGISTICS

**LTC Joel Franklin** addresses attendees as he accepts the position of product manager for joint logistics and sustainment from **LTC John O'Neill** July 11. The product management office is assigned to the Army Project Office for MRAP vehicles of PEO CS&CSS. (U.S. Army photo)



**HEMEYER TAKES OVER AT AVIATION DIRECTORATE**

PEO Aviation’s Lower Tier Project Office (LTPO) Program Management Directorate has a familiar face as its new director. **Daniel Hemeyer** was officially promoted to the position on May 2. Hemeyer started his career in the Patriot Security Assistance Management Directorate and worked through the ranks to become the chief of multinational programs, supporting numerous international Patriot programs. For the past seven years, he also has been serving as the chief of LTPO’s Life Cycle Management Division. He has more than 25 years of service to the Patriot team and family. (Photo by Donna Davis)



**NEW JAGM PRODUCT MANAGER**

**LTC Ron Volkin**, left, product manager for the Joint Air-to-Ground Missile in PEO Missiles and Space, was honored for his service June 5 as **LTC Philip G. Rottenborn**, right, succeeded him in the position. **COL James S. Romero**, project manager for Joint Attack Munition Systems, center, officiated. (Photo by Cathy Webster)



**SHEPARD SUCCEEDS WRIGHT AT PEO MISSILES AND SPACE**

**LTC Jonathon Shepard**, shown with **COL Gary Stephens**, project manager for precision fires rocket and missile systems, and Stephens’ wife, Jodi, is the new product manager for precision guided munitions and rockets at PEO Missiles and Space. On June 10, Shepard succeeded LTC T.J. Wright, who retired with 21 years of service. (Photo by Katherine Wayne)



**PASSING THE COLORS**

**MG Theodore C. “Ted” Harrison**, second from right, U.S. Army Contracting Command CG, passes the colors of U.S. Army Expeditionary Contracting Command (ECC) to incoming Commander **COL(P) Michael D. Hoskin** during the ECC assumption-of-command ceremony Aug. 1 at Redstone Arsenal as departing Executive Director **Bryan Samson** and **CSM Angel C. Clark**, center, look on. Hoskin has since been promoted to brigadier general. (U.S. Army photo by Ed Worley)



**THE NEW BOSS OF 413TH CSB**

**COL Kevin Nash** addresses the 413th Contracting Support Brigade (CSB) after assuming command during a ceremony aboard the USS Missouri, July 10. (Photo courtesy of 413th CSB)



**BEELER LEADS 414TH CSB**

**COL Christine A. Beeler** accepts the 414th Contracting Support Brigade guidon from **MG Theodore C. “Ted” Harrison**, CG of U.S. Army Contracting Command, during a July 10 change-of-command ceremony. Beeler succeeded **COL Paul Pardew** as brigade commander. (U.S. Army photo)



**TSCHIDA ASSUMES COMMAND OF 419TH CSB**

**COL Carol Tschida** passes the 419th Contracting Support Brigade colors to brigade **CSM Elicer Quintero** at a ceremony at Fort Bragg, NC, July 23, as she assumed command of the brigade. (U.S. Army photo)



### WRIGHT RETIRES

**LTC T.J. Wright**, who retired from the Army June 10 after 21 years of service, accepts the Legion of Merit from **COL Gary Stephens**, project manager for precision fires rocket and missile systems (PM PFRMS) in PEO Missiles and Space. Wright last served as the product manager for precision guided munitions and rockets in the PFRMS Project Office. (Photo by Katherine Wayne)



### HUFF RETIRES

**LTC Tom T. Huff**, center, product director for aviation rockets and small guided munitions, accepts the Legion of Merit from **BG L. Neil Thurgood**, PEO Missiles and Space. Huff retired after 27 years of military service at a June 19 ceremony in Huntsville, AL. At right is **COL James S. Romero**, project manager for Joint Attack Munition Systems. (Photo by Cathy Webster)



### GRIZIO TAKES OVER WARRIOR TRAINING INTEGRATION

**Jerry Sirmans**, left, acting project manager for constructive simulation, presents the charter of the product manager for warrior training integration to **LTC Vince Grizio** on July 25 at Program Executive Office for Simulation, Training and Instrumentation (PEO STRI) headquarters. (U.S. Army photo)



### WEAKLY TAKES OVER AIR AND COMMAND TACTICAL TRAINERS

**COL Harry Buhl**, left, project manager for Combined Arms Tactical Trainers, presents the charter of the product manager for Air and Command Tactical Trainers to **LTC Ed Weakley** on July 8 at PEO STRI headquarters. (U.S. Army photo)



### NEW BOSS AT LIVE TRAINING SYSTEMS

**LTC Corey Hemingway** speaks to the audience after assuming the charter as the product manager for Live Training Systems on July 11 at PEO STRI headquarters in Orlando, FL. (U.S. Army photo)



### TWITTY TO GROUND COMBAT TACTICAL TRAINERS

**COL Harry Buhl**, left, project manager for Combined Arms Tactical Trainers, presents the charter of the product manager for Ground Combat Tactical Trainers to **LTC Doug Twitty** on July 11 at PEO STRI headquarters. (U.S. Army photo)



### FLETCHER RETIRES AFTER 27 YEARS

**COL Robert Fletcher** retired from the Program Executive Office for Combat Support and Combat Service Support (PEO CS&CSS) after 27 years of service to the Army. **Kevin M. Fahey**, former PEO CS&CSS and now executive director for agile acquisition in the Office of the Assistant Secretary of the Army for Acquisition, Logistics and Technology (OASA(ALT)), presided at the ceremony May 1. (U.S. Army photo)



### OSBORNE RETIRES AFTER 34 YEARS

**COL Shawn Osborne** retired from PEO CS&CSS after 34 years of service. **Kevin M. Fahey**, former PEO CS&CSS and now executive director for agile acquisition in OASA(ALT), presided at the May 27 ceremony. (U.S. Army photo)



**RAUBINGER RETIRES FROM CIVIL SERVICE**

**Deborah Raubinger** retired from civilian service, culminating in her position as milestone decision actions coordinator for PEO CS&CSS). **COL(P) Brian P. Cummings**, left, Deputy PEO CS&CSS, presided at the June 5 ceremony. (U.S. Army photo)



**LEGION OF MERIT TO EPPS**

**MG Jonathan A. Maddux**, the PEO STRI, presents the Legion of Merit to **COL Wayne Epps** upon his departure as the project manager for constructive simulation. The award ceremony was held July 23 at PEO STRI headquarters. (U.S. Army photo)



**PDM AMS LAUDED FOR EXCEPTIONAL SUPPORT**

The 507th Engineer Battalion, Michigan Army National Guard recently presented the product manager for assured mobility systems (PdM AMS) with the Outstanding Center of Influence Award for the exceptional support that the PdM AMS team provided to the 507th before, during and after the unit's recent deployment in support of Operation Enduring Freedom (OEF).

**LTC James Flowers**, center, commander of the 507th, presented the PdM AMS team with the award, represented by the Minuteman statue, as well as a 507th Engineer Battalion coin. The Outstanding Center of Influence Award is awarded by a National Guard or Reserve unit to a business, group or individual for providing extraordinary support to National Guard or Reserve Soldiers during deployment.



**DUNCAN RECEIVES END-OF-TOUR AWARD**

**BG John A. George** and **MAJ Pat Duncan** stand at attention during the reading of orders authorizing the Army Commendation Medal for Duncan as an end-of-tour award. From July 2013 to June 2014, Duncan served as executive officer to George, director, Joint and Integration for the deputy chief of staff, G-8. (Photo by Marla Hurtado)



### FORCE DEVELOPMENT FULL DIMENSION PROTECTION STAFF HONORED

LTC **Thomas W. Spoehr**, director of the Office of Business Transformation in the Office of the Undersecretary of the Army and a former commandant of the U.S. Army Chemical, Biological, Radiological, and Nuclear (CBRN) School, presented the Honorable Order of the Dragon award to Full Dimension Protection (FDP) staff who developed procurement strategies to protect Soldiers against CBRN threats. Under the leadership of **Marjorie McCants**, right, deputy FDP division director, the division provides immediate equipping support while developing long-term fiscal strategies. (Photo by Marla Hurtado)



### ROSENKRANZ NAMED TO HALL OF FAME

**MG Robert M. "Bo" Dyess Jr.**, **MG Robert B. Rosenkranz (USA, Ret.)**, center, and **Don Tison**, assistant deputy chief of staff, G-8, celebrate Rosenkranz's induction into the U.S. Army Force Management Hall of Fame, May 29 at the Pentagon.

The Hall of Fame recognizes military and civilian personnel who made significant and lasting contributions in areas such as doctrine, manning and equipping. Rosenkranz played a major role as an Army force manager during a period of world-changing events and transition. Dyess is the director of force development for the deputy chief of staff, G-8, and oversees the activity of all U.S. Army force managers. (Photo by Marla Hurtado)



### SERVICE AWARD FOR CALLICUTT

**Pamela Callicutt** receives the Meritorious Civilian Service Award from **Harry P. Hallock**, deputy assistant secretary of the Army for procurement (DASA (P)), for leading the development, implementation and review of the Army's Acquisition Strategies Approval process for acquisition of services and the revision of Army Regulation 70-13, "Management and Oversight of Service Acquisitions." Callicutt has 32 years of experience in contracting, including more than 20 years on active duty in addition to her civilian career as a procurement analyst. (Photo by Kathie Scarrah, Office of the DASA(P))



### SERVICE AWARD FOR COSSENTINO

**Melissa Cosentino** receives the Superior Civilian Service Award from **Harry P. Hallock**, deputy assistant secretary of the Army for procurement (DASA(P)). Cosentino was recognized for her exceptional performance while serving as the director for review and oversight in the Office of the DASA(P). She is Level III certified in contracting and a member of the Army Acquisition Corps with 18 years of service. She is currently a student at the Dwight D. Eisenhower School for National Security and Resource Strategy in Washington, DC. (Photo by Kathie Scarrah, Office of the DASA(P))

# THEN & NOW

## AN ABIDING MISSION

The first issue of Army AL&T magazine—then the Army Research & Development (R&D) Newsmagazine, the monthly publication of the Army’s chief of research and development—appeared on Dec. 1, 1960, and declared its mission clearly and succinctly. Richard S. Morse, the DA’s director of research and development, said about the fledgling publication:

“The Army Research and Development Newsmagazine is the result of a long considered analysis of the problem of maintaining more effective communication within the Army R&D establishment and with other Government agencies directly or indirectly contributing to the success of our program. Properly supported by submission of pertinent information from all Army R&D activities, this monthly periodical should perform a most valuable service in presenting reports on significant gains, overall progress and objectives, the views or policies of management, measures being taken to cope with problems of interest to all personnel, and accounts of

how people are accomplishing their jobs and gaining deserved recognition.”

Despite the many changes affecting it in the past 54 years, including the founding in 1989 of the Army Acquisition Corps, this publication has not wavered from that mission. The changes have been many—from monthly to bimonthly to quarterly publication, from black and white to full color, from the name Army Research and Development Newsmagazine to Army RD&A magazine to Army AL&T magazine, now available in an electronic edition that would have been the stuff of science fiction in 1960. Despite all this, Army AL&T magazine has continued to provide pertinent information of interest to all personnel. This magazine has been central, as Morse put it, to “maintaining more effective communication within the Army R&D” and acquisition community, now the Army Acquisition, Logistics and Technology Workforce.

LTG Arthur G. Trudeau, then the Army’s chief of research and development, took a “keen personal interest in the founding of

the magazine,” saying, “Many commercial publications are doing a fine job of reporting on what they consider newsworthy results of Army research and development insofar as they are designed to appeal to large segments of readers, or to satisfy specific interests of professional and scientific groups.

“From our viewpoint, however, none of the commercial publications has attempted to present, specifically for the audience toward which the Newsmagazine is directed, a broad picture of the overall depth and scope of the Army research and development program to fill a very real need for dissemination of the special kinds of information our new publication will contain. It should be clear that the Newsmagazine is not intended to compete with professional journals or other commercial news media.

*“My desire is that the Newsmagazine will be able to furnish, through the complete cooperation of all agencies and individuals concerned, the kind of information that will build pride of service, stimulate unity of purpose, and help to eliminate duplicatory or wasteful rivalry. Its aim will be to impose understanding of problems related to our mission and to foster teamwork in planning, integrating, and coordinating our programs. It will reflect the Army’s desire to blend its programs with all of the Nation’s other R&D activities, insofar as it is practicable, in solving problems of building military strength expeditiously.”* The emphasis was Trudeau’s.

People may have come and gone, organizations may have changed entirely since 1960, but that desire and mission to inform what we today call the Army AL&T Workforce remains the heart of this magazine.

### STAYING THE COURSE

From its early days as Army Research and Development Newsmagazine to its current iteration, AL&T Magazine has stayed true to its founder’s aim to foster teamwork in planning, integrating and coordinating acquisition programs.



# CONGRATULATIONS TO THE U.S. ARMY ACQUISITION CORPS FOR 25 YEARS OF ACQUISITION EXCELLENCE.



# US ARMY PEOEIS

PEO ENTERPRISE INFORMATION SYSTEMS



[www.eis.army.mil](http://www.eis.army.mil)

[www.twitter.com/PEOEISPAoffice](https://www.twitter.com/PEOEISPAoffice)

[www.facebook.com/PEO.EIS](https://www.facebook.com/PEO.EIS)



---

ARMY ACQUISITION, LOGISTICS & TECHNOLOGY  
ISSN 0892-8657

DEPARTMENT OF THE ARMY  
ARMY AL&T  
9900 BELVOIR RD  
FT BELVOIR, VA 22060-5567

ASC.ARMY.MIL

---

HEADQUARTERS DEPARTMENT OF THE ARMY | PB 70-14-04 | APPROVED FOR PUBLIC RELEASE: DISTRIBUTION IS UNLIMITED

---



“You enable the world’s greatest Army. Don’t ever forget that. Everybody else in this world wants what we have. The reason they want what we have is because we’re the best. Everybody wants to buy our product, everybody wants to steal our product, because we’re the best. Don’t ever forget that. Give yourselves some credit.”

**Heidi Shyu**

*Assistant Secretary of the Army  
for Acquisition, Logistics and Technology  
(ASA(ALT))/Army Acquisition Executive*

PUBLISHED BY



*Sept. 10, 2014  
Redstone Arsenal, AL*